



## IBX100 ELECTRONIC CONTROL UNIT





**4679004**  
**46790042**

Object Pool rel. 3.6.x

---

**INSTALLATION, USE AND MAINTENANCE**

	= Generic danger
	= Warning
<b>ECU</b>	= IBX100 remote control unit
<b>VT</b>	= Virtual Terminal
<b>OP</b>	= Object Pool
<b>TC</b>	= Task Controller

**WARNING:**  
**THE NATIVE CONTROLS INSIDE YOUR VIRTUAL TERMINAL HAVE THE PRIORITY ON ALL THE CONTROLS DERIVING FROM THE IBX100. PLEASE, KEEP THIS IN MIND WHEN PROGRAMMING AND USING THE PRODUCT.**

<b>1</b>	<b>Risks and protections before assembly</b> .....	<b>4</b>	<b>12</b>	<b>Data and Settings</b> .....	<b>43</b>
<b>2</b>	<b>Intended use</b> .....	<b>4</b>	12.1	Manage presets .....	43
<b>3</b>	<b>Precautions</b> .....	<b>4</b>	12.2	Working parameters .....	46
<b>4</b>	<b>Package content</b> .....	<b>4</b>	12.3	Info and alarms .....	47
<b>5</b>	<b>Position on farming machine</b> .....	<b>5</b>	12.4	implement settings .....	49
5.1	System recommended composition .....	5	12.5	Job data .....	49
5.2	Control unit fixing .....	8	12.6	Sprayer capability .....	50
5.3	Wiring harness connection .....	9	12.7	System .....	51
<b>6</b>	<b>Wiring connections</b> .....	<b>11</b>	12.7.1	Device status .....	51
6.1	General precautions for a correct harness position .....	11	12.7.2	SOBUS .....	52
6.2	Control unit (ECU) connection .....	11	12.7.3	Auxiliary input status .....	53
6.3	Securing the Seletron cables .....	12	12.7.4	System settings .....	54
6.4	Control unit valve connection .....	14	12.7.5	Registration .....	59
	Section valves .....	14	12.7.6	Seletron status .....	59
	NOZZLE HOLDER BOOM A .....	14	12.8	User preferences .....	60
	NOZZLE HOLDER BOOM B .....	14	<b>13</b>	<b>Seletron connection</b> .....	<b>61</b>
	NOZZLE HOLDER BOOM A .....	14	13.1	Seletrons Test .....	63
	Section valves .....	14	13.2	ID Reset .....	63
	NOZZLE HOLDER BOOM B .....	14	13.3	SELETRON REPLACEMENT .....	64
6.5	FENCE NOZZLE CONNECTION - Installation with section valves - Fig. 3 .....	15	13.3.1	Preliminary Operations .....	64
6.6	FENCE / BUFFER NOZZLE connection - Installation with Seletron system - Fig. 4 .....	15	13.3.2	Replacement procedure .....	64
6.7	Hydraulic valve connection .....	15	<b>14</b>	<b>Use</b> .....	<b>66</b>
6.8	Sensor connection .....	16	14.1	"HOME" main screen .....	66
<b>7</b>	<b>ISOBUS system cable connection</b> .....	<b>17</b>	<b>15</b>	<b>Job functions</b> .....	<b>67</b>
7.1	Connection of in-cab cable .....	17	15.1	Output temporary increase and decrease - Home page > Change target rate .....	67
7.2	Connection of ISOBUS cable .....	17	15.2	Home > Alarms .....	67
<b>8</b>	<b>Foreword</b> .....	<b>18</b>	15.3	Home > Automatic functions .....	68
8.1	"OBJECT POOL" loading .....	18	15.3.1	Home > Automatic functions > Application rate regulation... 68	68
8.2	Loading of "Second Sprayer OBJECT POOL" .....	18	15.3.2	Home > Automatic functions > Nozzles selection .....	69
<b>9</b>	<b>Setting</b> .....	<b>19</b>	15.3.3	Home > Automatic functions > Simulated speed .....	70
9.1	Tests and checks before setting .....	19	15.3.4	Home > Automatic functions > Light switches .....	70
9.2	Control layout .....	19	15.4	Home > Tank .....	71
<b>10</b>	<b>Implement settings &gt; BASIC SETTINGS</b> .....	<b>20</b>	15.5	Main control and section management .....	73
<b>11</b>	<b>Implement settings &gt; Advanced Setup</b> .....	<b>22</b>	15.5.1	Control settings WITH Auxiliary Input .....	73
11.1	Boom .....	23	15.5.2	Control settings WITHOUT Auxiliary Input .....	73
11.2	Flowmeters .....	24	17.1	End nozzles .....	78
11.3	Pressure sensor .....	25	17.2	Home > Seletron manual control .....	80
11.4	Valves .....	26	17.3	Home > Pump rate control type .....	80
11.5	Nozzle data .....	27	17.4	Home > Section control .....	80
11.6	Speed .....	28	17.5	Home > Syncro control .....	81
11.7	Rev counter .....	28	<b>18</b>	<b>Maintenance / diagnostics / repairs</b> .....	<b>82</b>
11.8	Tank .....	29	18.1	Cleaning rules .....	82
11.9	Hydraulic functions .....	30	18.2	LED status key .....	82
11.10	Device calibration .....	32	18.3	Error messages .....	83
11.10.1	Press. sensor zero value .....	33	18.4	Troubleshooting .....	84
11.10.2	Tank level zero value / Tank 2 level zero value .....	33	19.4	Pin-out of IBX100 .....	85
11.10.3	Tank profile calibration .....	34	<b>19</b>	<b>Technical data</b> .....	<b>87</b>
11.10.4	Save tank profile .....	35	19.1	Electrical features .....	87
11.10.5	Load tank profile / Load tank 2 profile .....	36	19.2	Environmental features .....	87
11.11	Implement geometry .....	37	19.3	Physical features .....	87
11.12	System configurations .....	38	<b>20</b>	<b>End-of-life disposal</b> .....	<b>87</b>
11.14	"Fence" .....	41	<b>21</b>	<b>Guarantee terms</b> .....	<b>87</b>
11.15	Flowmeter presets .....	42	<b>22</b>	<b>EU declaration of conformity</b> .....	<b>87</b>

## • MANUAL USE MODES

The section of this manual dedicated to the installation contains information for installers. For this reason, we used technical terms without providing explanations which would be necessary for end users only.

**THE INSTALLATION MUST BE CARRIED OUT BY AUTHORIZED AND SKILLED PERSONNEL ONLY. ARAG IS NOT RESPONSIBLE FOR ANY OPERATION SPECIFIED IN THIS MANUAL CARRIED OUT BY UNAUTHORIZED OR UNSKILLED PERSONNEL.**

## • LIMITATIONS

The descriptions of the assembly phases refer to a "general" Virtual Terminal, so specific models will not be mentioned, unless a certain installation procedure concerns exclusively one VT type.

## • RESPONSIBILITIES

The installer must carry out "workmanlike" installations and ensure to the end user the perfect operation of the whole system both with ARAG components only and other brands' components.

ARAG always recommends using its components to install control systems.

The installer will be held responsible for any malfunction if he decides to use other brands' components even without actually changing the system parts or harness.

The compatibility check with components and accessories of other manufacturers shall be carried out by the installer.

If the ARAG components installed together with other brands' components get damaged because of what stated above, no direct or indirect warranty will be provided.

## 1 RISKS AND PROTECTIONS BEFORE ASSEMBLY

The installation works relating to the IBX100, except the main connection (ISOBUS system Chap. 7) must be done with battery disconnected, using suitable tools and any individual protection equipment deemed necessary.



Use **ONLY** clean water for treatment tests and simulations: using chemicals during simulated treatment runs can seriously injure persons in the vicinity.

## 2 INTENDED USE

The equipment you have purchased is a standard ISOBUS system compliant with ISO11783 to be applied to a crop spraying boom.

**This device is designed to work on agricultural machinery for spraying and crop spraying applications.**

**The machine is designed and built in compliance with ISO 14982 standard (Electromagnetic compatibility - Forestry and farming machines), harmonized with EMC - 2014/30/EU Directive.**

## 3 PRECAUTIONS



- Do not aim water jets at the equipment.
- Do not use solvents or fuel to clean the case outer surface.
- Do not clean equipment with direct water jets.
- Comply with the specified power voltage (12 VDC).
- In case of voltaic arc welding, remove connectors from the device and disconnect the power cables.
- Only use ARAG genuine spare parts and accessories.



**CONNECTED TO A SUITABLE ISOBUS CONTROL UNIT, THE DEVICE CAN CARRY OUT ELECTROMECHANICAL CONTROL OPERATIONS.**

**THE PRODUCT DOES NOT FEATURE EMERGENCY STOP DEVICES: THE MACHINE MANUFACTURER MUST PROVIDE ALL NECESSARY SAFETY DEVICES FOR THE EQUIPMENT. IT IS THE MANUFACTURER'S RESPONSIBILITY TO ENSURE THAT THE MACHINE IS SAFE TO USE, ALSO BY MEANS OF ACOUSTIC AND/OR VISUAL SIGNALING DEVICES.**

## 4 PACKAGE CONTENT



Fig. 1

- Control unit



Harnesses must be ordered separately  
(Ref. ARAG general catalog).

**5 POSITION ON FARMING MACHINE**

**5.1 System recommended composition**

**⚠ WARNING: DO NOT CONNECT THE ISOBUS CONNECTOR (Cap. 7 on page 17). THIS CONNECTION MUST BE CARRIED OUT LATER, ONLY AFTER INSTALLING ALL THE COMPONENTS.**

To connect all parts of the system correctly, make sure to use the proper connection cables. Consider all possible variants:

- type of system,
- type of Seletron units connected (single, twin or fourfold)
- number of nozzles per mechanical arm (of spraying boom)

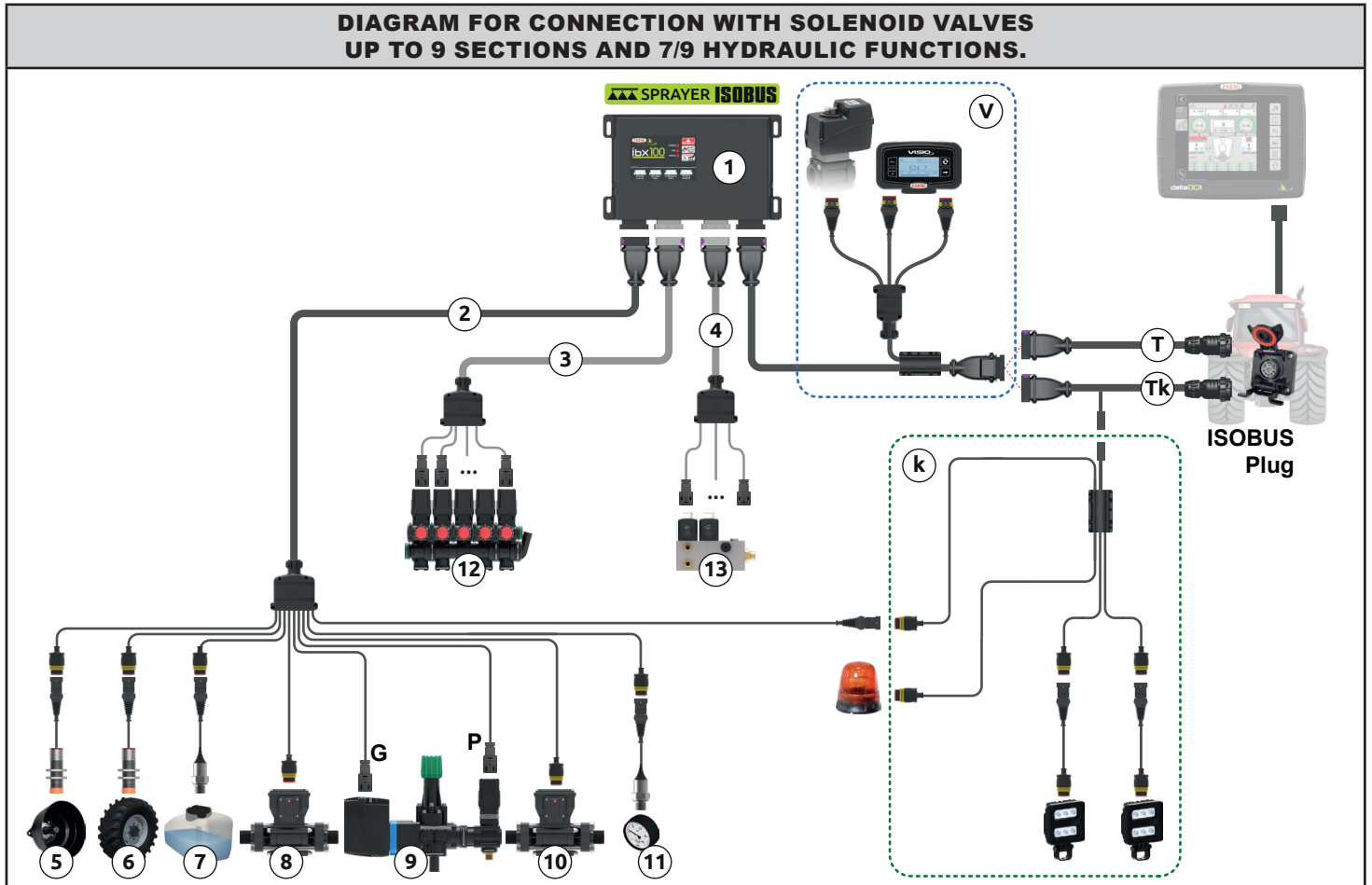

Fig. 2

**Legend:**

- 1** IBX100 Sprayer ISOBUS control unit
- 2** Sensor cables 3 m long + main valve G + regulating valve P
- 3** Water valve connection cable (up to 9 sections) - 3.5 m long
- 4** Connection cable for hydraulic valves 7 / 9 oil functions - 3 m long
- 5** RPM sensor
- 6** Inductive speed sensor with cable - 5 m long
- 7** Level sensor
- 8** Filling flowmeter
- 9** Control unit (main valve G + regulating valve P)
- 10** Flowmeter
- 11** Pressure sensor
- 12** Control unit (section valves: up to 9 sections)
- 13** Hydraulic control unit
- T** IBX100 connection cable, tractor (ISOBUS PLUG) - 3 / 6 / 10 / 14 / 18 m long
- Tk** IBX100 connection cable, tractor (ISOBUS PLUG) - 3 / 6 / 10 / 14 / 18 m long, trailer light kit (optional)
- k** Light control kit
- V** Visio connection and valve input (optional)

**WARNING: DO NOT CONNECT THE ISOBUS CONNECTOR** (Cap. 7 on page 17).  
**THIS CONNECTION MUST BE CARRIED OUT LATER, ONLY AFTER INSTALLING ALL THE COMPONENTS.**

To connect all parts of the system correctly, make sure to use the proper connection cables.

Consider all possible variants:

- type of system,
- type of Seletron units connected (single, twin or fourfold)
- number of nozzles per mechanical arm (of spraying boom)

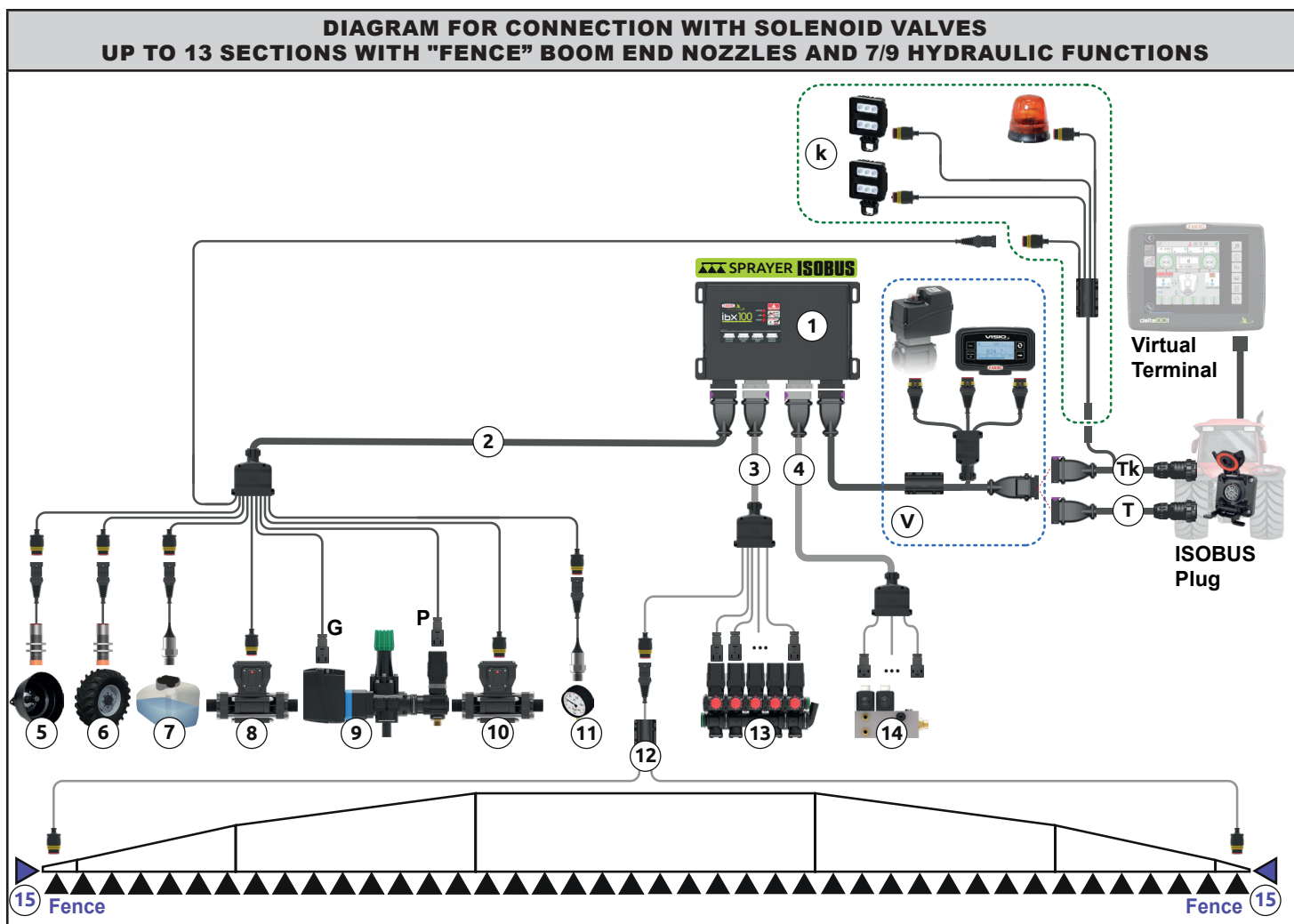

Fig. 3

**Legend:**

- 1 IBX100 Sprayer ISOBUS control unit
- 2 Sensor cables 3 m long + main valve G + regulating valve P
- 3 Water valve connection cable (up to 13 sections) - 3,5 m long + "Fence" boom end nozzles
- 4 Connection cable for hydraulic valves 7 / 9 oil functions - 3 m long
- 5 RPM sensor
- 6 Inductive speed sensor with cable - 5 m long
- 7 Level sensor
- 8 Filling flowmeter
- 9 Control unit (main valve G + regulating valve P)
- 10 Flowmeter
- 11 Pressure sensor
- 12 Boom end connection cable for Seletron - 19 m long
- 13 Control unit (section valves: up to 13 sections)
- 14 Hydraulic control unit
- 15 "Fence" boom end nozzles

CONTINUES >>>

**WARNING: DO NOT CONNECT THE ISOBUS CONNECTOR (Cap. 7 on page 17). THIS CONNECTION MUST BE CARRIED OUT LATER, ONLY AFTER INSTALLING ALL THE COMPONENTS.**

To connect all parts of the system correctly, make sure to use the proper connection cables. Consider all possible variants:

- type of system,
- type of Seletron units connected (single, twin or fourfold)
- number of nozzles per mechanical arm (of spraying boom)

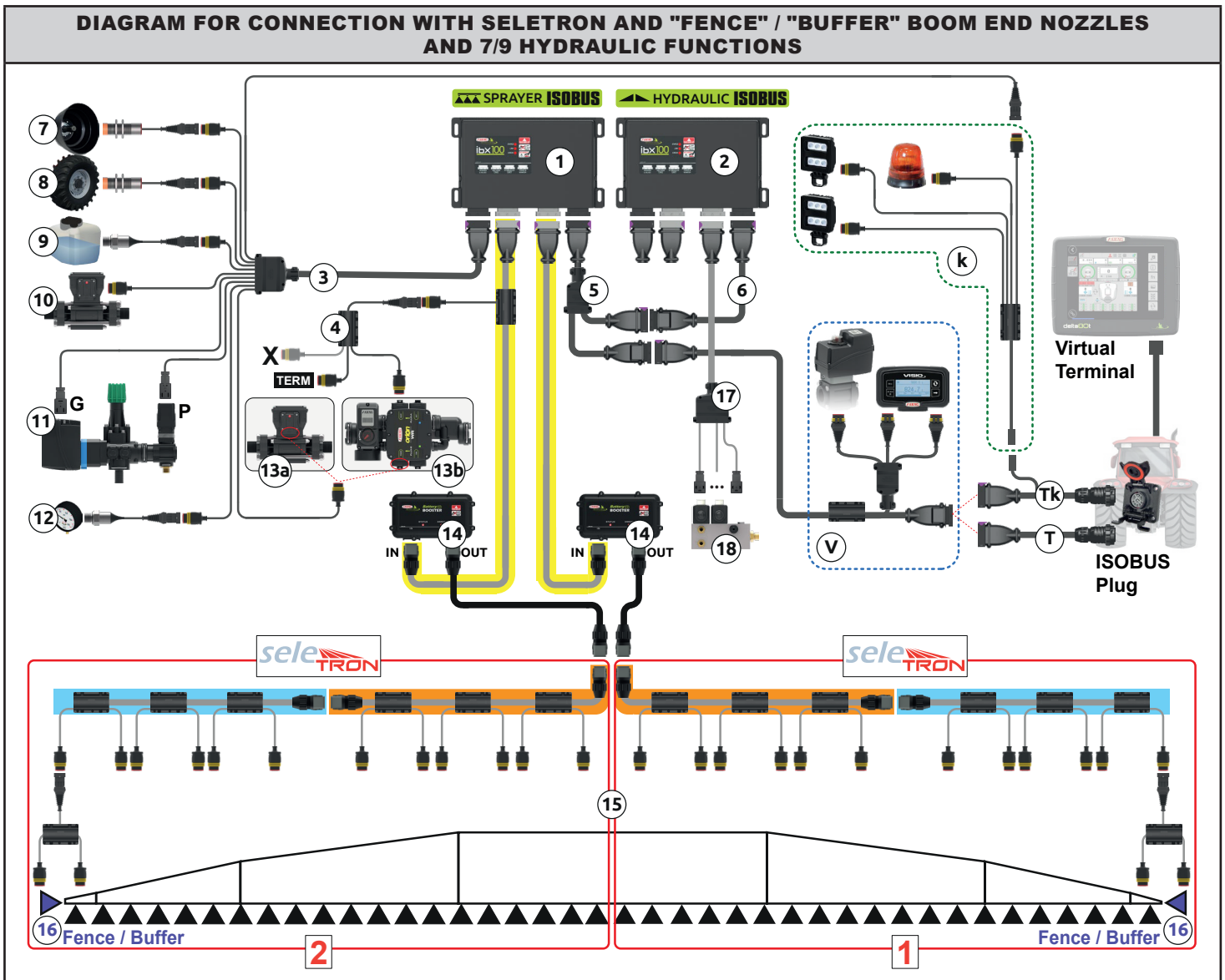

Fig. 4

**Legend:**

- 1** IBX100 Sprayer ISOBUS control unit
- 2** IBX100 Hydraulic ISOBUS control unit
- 3** Sensor cables 3 m long + main valve G + regulating valve P
- 4** Orion WR connection cable - 2 m long
- 5** Power and connection cable between IBX100 Sprayer ISOBUS and IBX100 Hydraulic ISOBUS
- 6** IBX100 power and communication extension - 3 / 6 / 10 m long (optional)
- 7** RPM sensor
- 8** Inductive speed sensor with cable - 5 m long
- 9** Level sensor
- 10** Filling flowmeter
- 11** Control unit (main valve G + regulating valve P)
- 12** Pressure sensor

**13a** Flowmeter or **13b** Orion WR flowmeter

**14** Battery Booster Kit

**15** Seletron line **1** and line **2** cables:

central cables

extension cables

termination cables

**16** "Fence" and "Buffer" boom end nozzles

**17** Connection cable for hydraulic valves 7 / 9 oil functions - 3 m long

**18** Hydraulic control unit

**T** IBX100 connection cable, tractor (ISOBUS PLUG) - 3 / 6 / 10 / 14 / 18 m long

**Tk** IBX100 connection cable, tractor (ISOBUS PLUG) - 3 / 6 / 10 / 14 / 18 m long, trailer light kit (optional)

**k** Light control kit (optional)

**V** Visio connection and valve input (optional)

**Without Battery Booster, correct operation cannot be ensured, because the features of the power source to the ISOBUS socket are unknown.**

**Maximum number of Seletron units that can be connected with Battery Booster:**

**Single / Twin Seletron units: 128**

**Fourfold Seletron units: 72**

5.2 Control unit fixing

Secure the control units on the back of the machine, close to the control unit and the hydraulic unit.



Consider all necessary connections of the device (par. 5.3), the cable length, and make sure there is enough space for connectors and cables.

For any reference to the system configuration, read par. 5.1.

Respect the mounting direction of the control units, as specified in Fig. 5 (connectors shall be facing down).

Fix the ECU using the 4 bolts fitted into their slots (A, Fig. 5).



No other type of assembly is allowed.

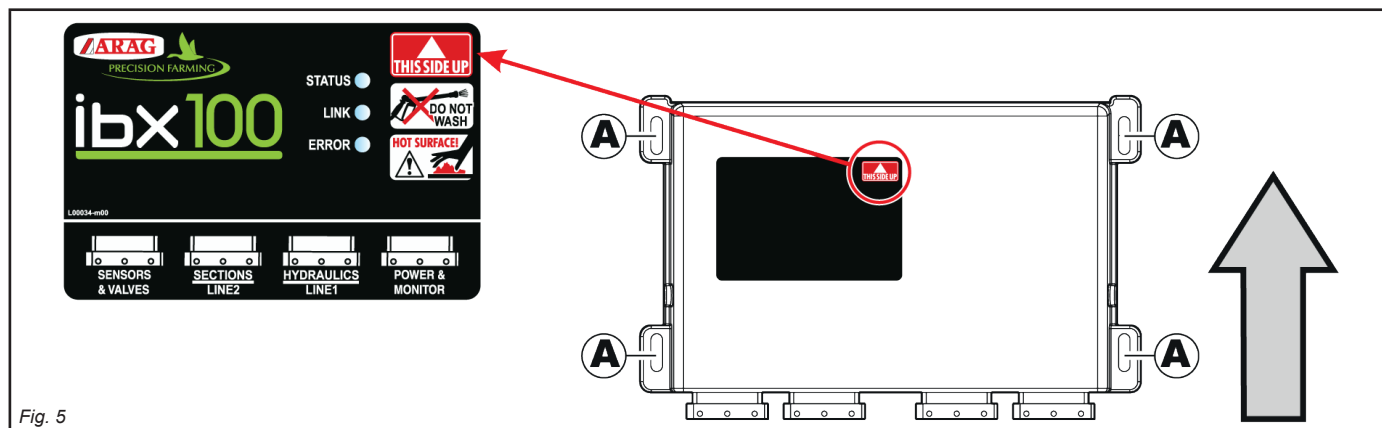

Fig. 5

OVERALL DIMENSIONS

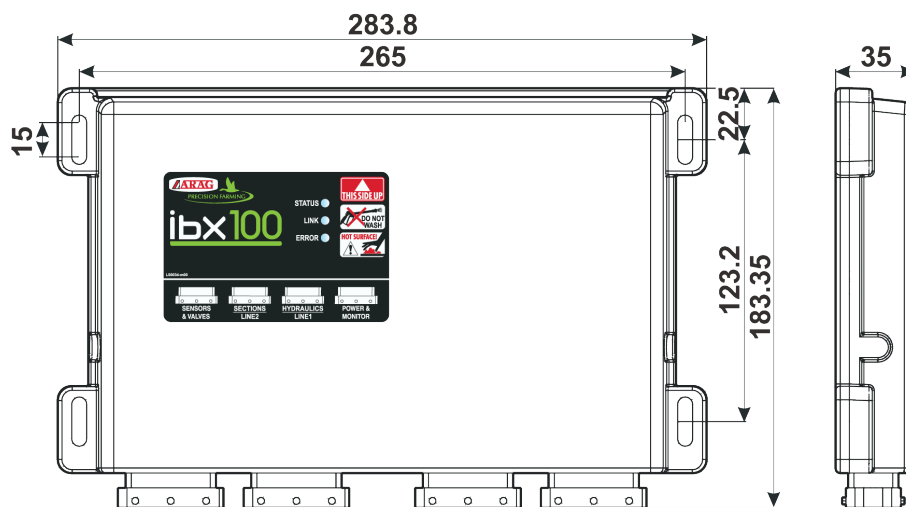

Fig. 6

Unit of measurement: mm



5.3 Wiring harness connection

**DIAGRAM FOR CONNECTION WITH SOLENOID VALVES  
UP TO 9 SECTIONS AND 7/9 HYDRAULIC FUNCTIONS**

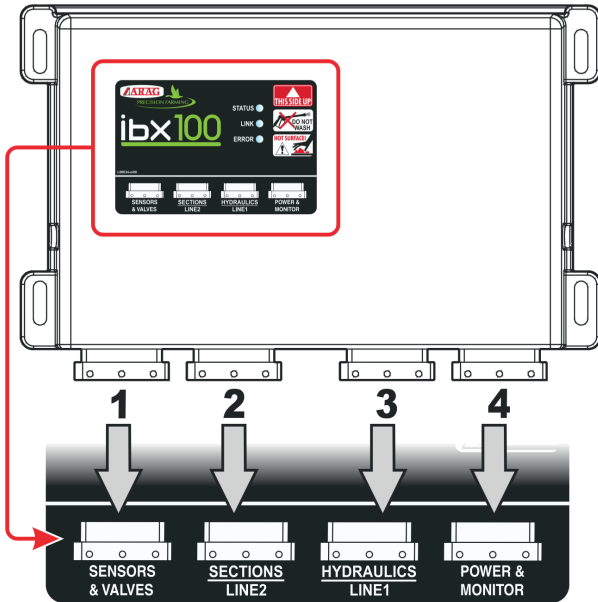

NO.	CONNECTION POINTS
1	Control unit (G + P) + Sensors
2	Control unit (section valves)
3	Hydraulic unit
4	Standard ISOBUS connector (ISOBUS PLUG)

Fig. 7

**DIAGRAM FOR CONNECTION WITH SOLENOID VALVES  
UP TO 13 SECTIONS WITH "FENCE" / "BUFFER" BOOM END NOZZLES AND 7/9 HYDRAULIC FUNCTIONS**

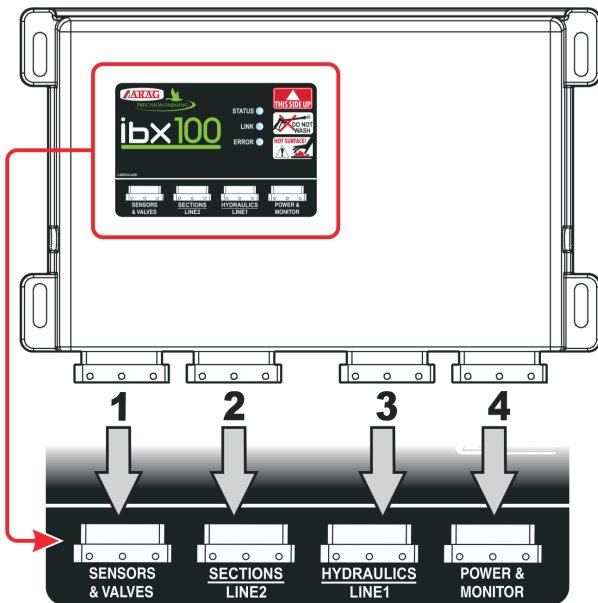

NO.	CONNECTION POINTS
1	Control unit (G + P) + Sensors
2	Control unit (section valves)
3	Hydraulic unit
4	Standard ISOBUS connector (ISOBUS PLUG)

Fig. 8

CONTINUES >>>

**DIAGRAM FOR CONNECTION WITH SELETRON AND "FENCE" / "BUFFER" BOOM END NOZZLES AND 7/9 HYDRAULIC FUNCTIONS**

**SPRAYER ISOBUS**

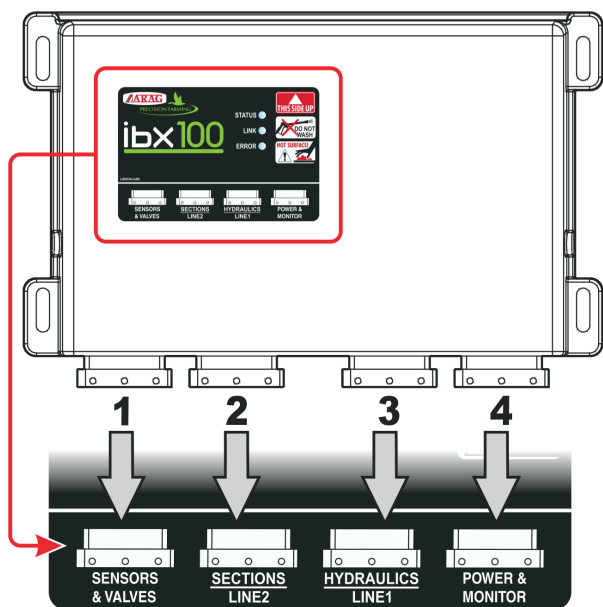

Fig. 9

NO.	CONNECTION POINTS
1	Control unit (G + P) + Sensors
2	Seletron - Line 2
3	Seletron - Line 1
4	Standard ISOBUS connector (ISOBUS PLUG)

**HYDRAULIC ISOBUS**

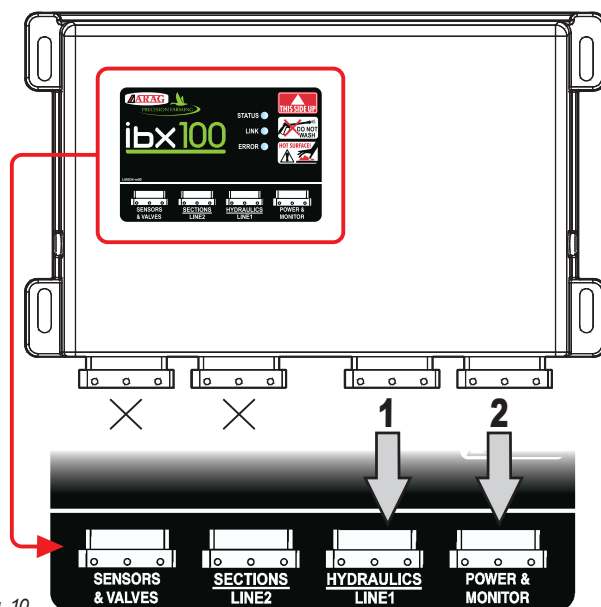

Fig. 10

NO.	CONNECTION POINTS
1	Hydraulic unit
2	ECU IBX100 Sprayer

**6 WIRING CONNECTIONS**

- Use original ARAG harnesses only.
- Take care not to break, pull, tear or cut the cables.
- Use of unsuitable cables not provided by ARAG automatically voids the warranty.
- ARAG is not liable for any damage to the equipment, persons or animals caused by failure to observe the above instructions.

**6.1 General precautions for a correct harness position**

- **Securing the cables:**
  - secure the harness so that it does not interfere with moving parts;
  - route the harnesses so that they cannot be damaged or broken by machine movements or twisting.
- **Routing the cables to protect against water infiltrations:**
  - the cable branches must ALWAYS be facing down (Fig. 11).

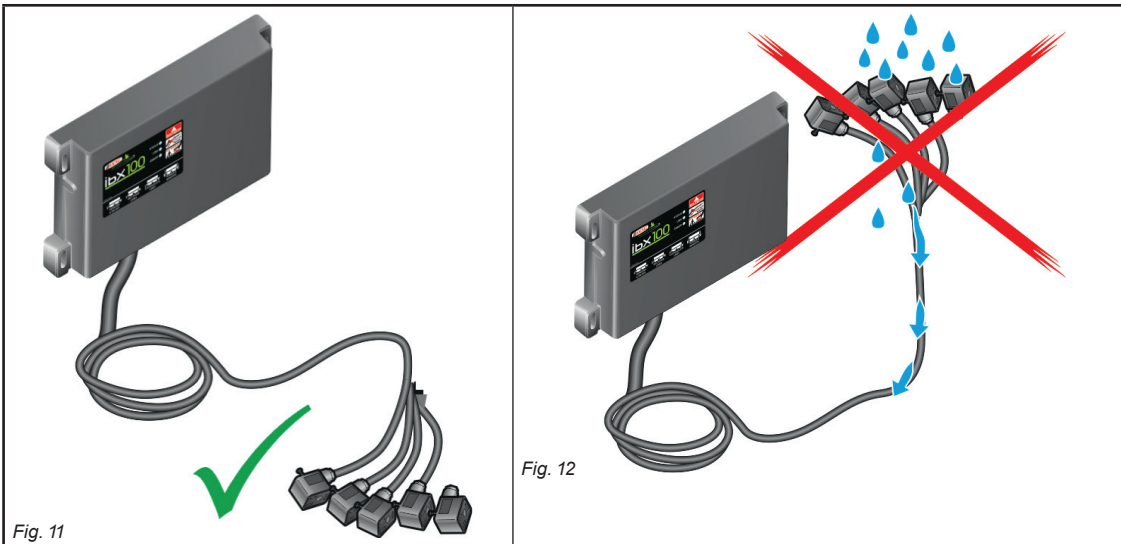

- **Fitting the cables to the connection points:**
  - Do not force the connectors by pushing too hard or bending them: the contacts may be damaged and system operation may be compromised.

 Use ONLY the cables and accessories indicated in the catalog, having technical features suitable for the use to be made of them.

**6.2 Control unit (ECU) connection**

 **WARNING: DO NOT CONNECT ISOBUS CONNECTOR (Fig. 7, Fig. 8, Fig. 9 e Fig. 10). THIS CONNECTION MUST BE CARRIED OUT LATER, ONLY AFTER INSTALLING ALL THE COMPONENTS (Chap. 7 ISOBUS system cable connection).**

Connect harnesses as specified in par. 5.3; each one of them shall be connected to the corresponding socket on the offset unit. Close the unused connectors with the relevant caps supplied in the package.

 If they prove hard to insert, do not force them, but check the shown position.

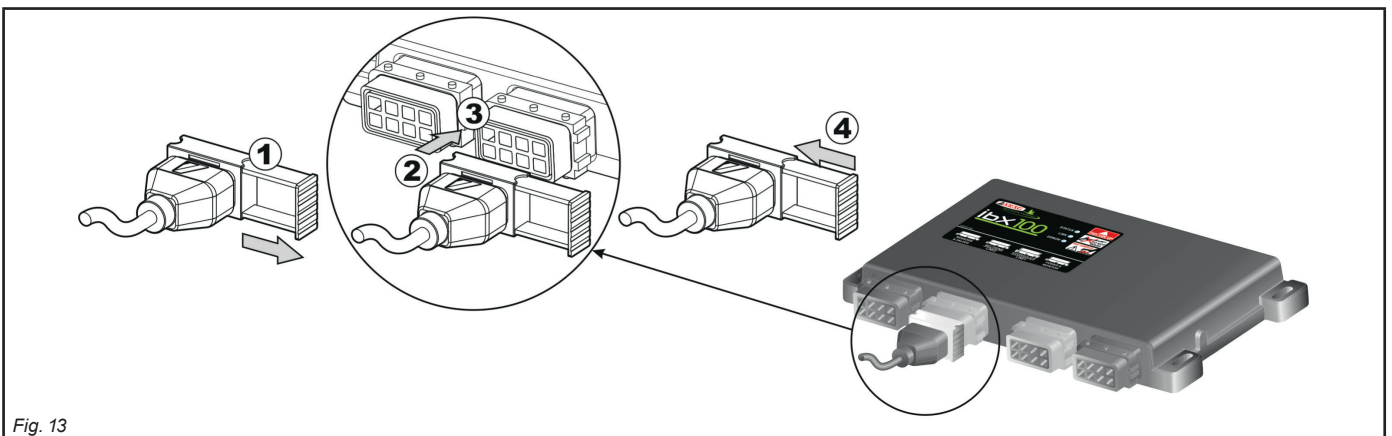

 Some connectors are supplied with separated slide. Manually insert the slide in the most convenient position for connector insertion and removal.

- Open connector slide (1, Fig. 13).
- To position connector (2), insert it inside socket (3), then press: during this operation, take care not to bend the electric contacts.
- Close slide (4) until it locks in place.

6.3 Securing the Seletron cables

**WARNING: DO NOT CONNECT THE CONNECTORS TO THE SELETRON NOZZLE HOLDERS. THE SELETRON ELECTRIC CONNECTORS MUST BE CONNECTED AT A LATER TIME, DURING THE PAIRING PROCEDURE (chap. "13 Seletron connection" on page 61).**

Route the cable following these rules:

**1** The Seletron units are connected to the ECU (Fig. 14) via two main wiring harnesses (**1** and **2**), each made up of three types of cables: head-end cable (**3**), extension cable (**4**) and termination cable (**5**); ; the termination cable is indispensable in order to close circuit. **The system will not operate without a termination cable.**

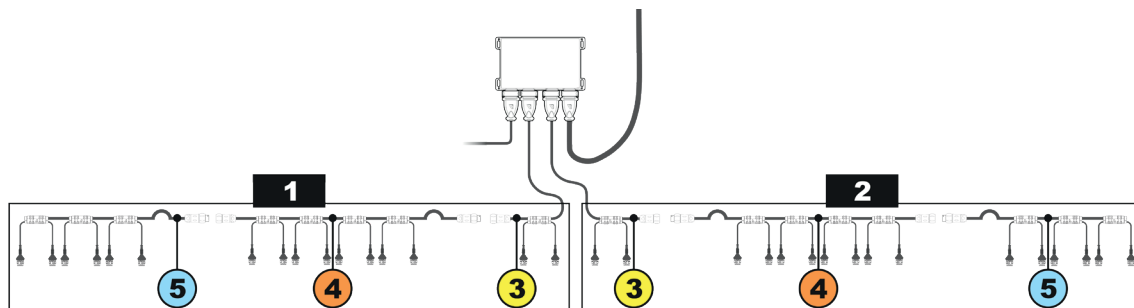

Fig. 14

Consider all necessary connections of the Seletron system, the cable length, and make sure there is enough space for connectors and cables. Secure the cables with ties to protect them from damage.

Thanks to the modular concept of the system, additional **EXTENSION** cables can be added to the circuit to connect additional nozzle holders and obtain the desired boom length.

To ensure proper operation of the system, observe the wiring diagram and use **ONLY** dedicated cables for the type of Seletron installed.

**WARNING: THE CABLES DESIGNED FOR CONNECTING TWIN SELETRON UNITS ON BOOMS UP TO 24 M LONG SHOULD NEVER BE USED ON LONGER BOOMS.**

**2** ECUs, main control valve, flowmeter and pressure sensor must be installed in the front section of the machine; if needed, **ONLY** the sensors may be moved to a different position and connected using the extensions listed in the catalog.

**Never use an extension for any other components unless you have so agreed with the ARAG Assistance Center.**

**3** Choose and install the cables so that they retain some freedom of movement at boom joints.

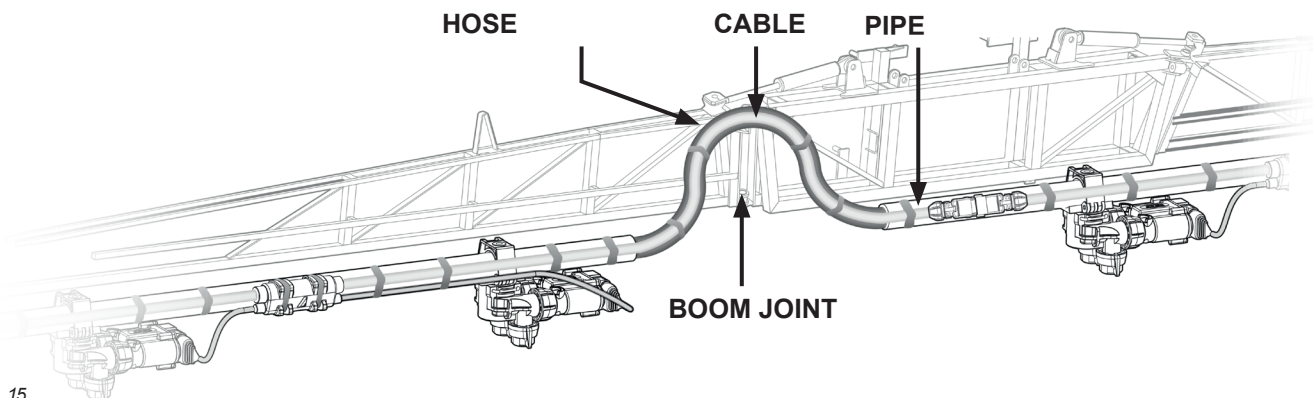

Fig. 15

**4** ALWAYS secure the main cable connections (**3**, **4** and **5**) to a stationary section of the boom; the head-end cable is longer than the termination to facilitate this.

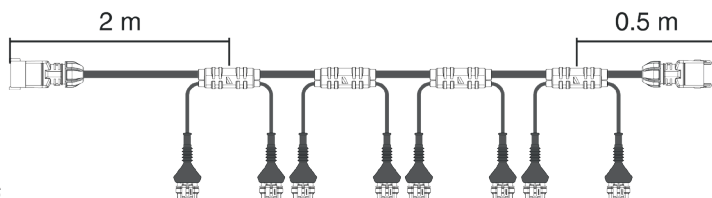

Fig. 16

**5** Account for any possible boom movement when positioning and fixing the cables.

**6** Connections between main cables (**3**, **4** and **5**). Observe connector position and do not force fitting: position is correct when **A** guides (Fig. 17) fit guiding connection to the complementary part.

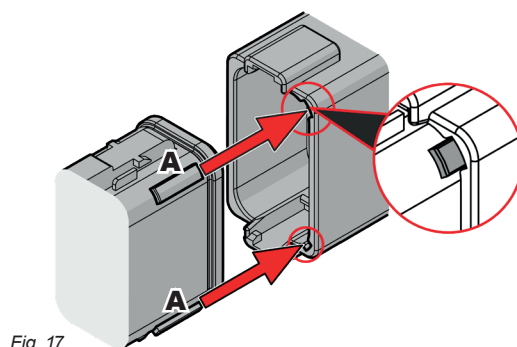

Fig. 17

**7** Carefully check that no connections or branches are positioned near moving parts and high enough to clear possible obstacles on the ground. Ensure that the Seletron nozzle holders do not become jammed with one another or touch any cables or delicate system areas when the boom is closed or folded away.

8 If space is limited and you need to bend a cable, be sure not to bend it too tight or it may get damaged.

**OK**

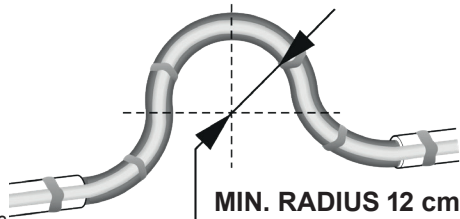
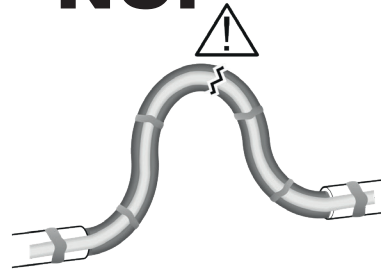

Fig. 18

**NO!**



9 Position the cable so that branches **A** are equally spaced from Seletron connectors **B**.

**NO!**

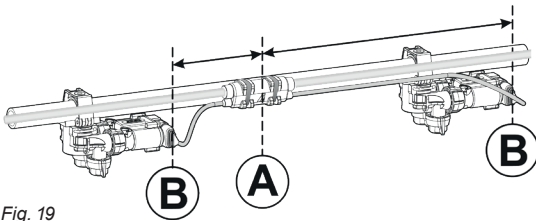
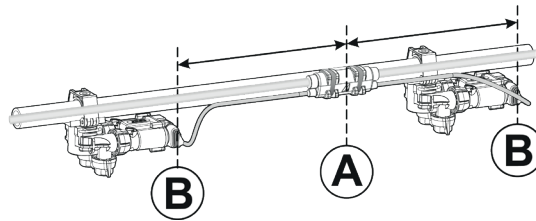

Fig. 19

**OK**



10 Secure the branches to the boom threading the ties through the suitable recesses.

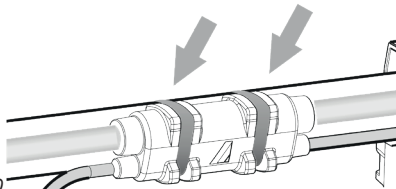

Fig. 20

11 When installing a twin or fourfold nozzle holder, make sure that all connectors are facing the same direction, or the computer might select the wrong nozzle.

**OK**

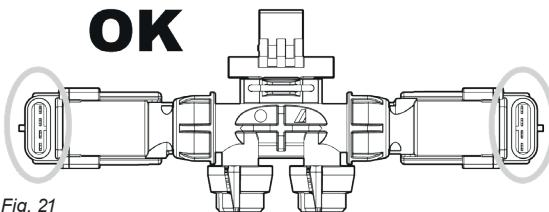
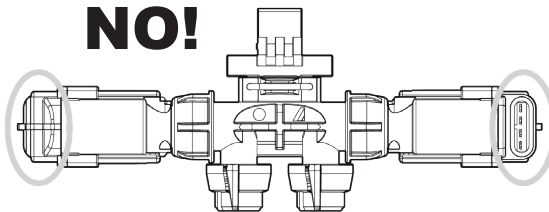

Fig. 21

**NO!**



For special needs it is possible to install two nozzles on boom ends that can work instead of the standard outer nozzles.

12 Any Seletron connectors left unused must be closed using the suitable plugs (code ECS0075). The plugs must be ordered separately. When the connectors are plugged off, the Seletron is sealed. To avoid damaging the internal components, make sure that when using or cleaning the system the plugs and the connectors are not bare or inserted incorrectly.

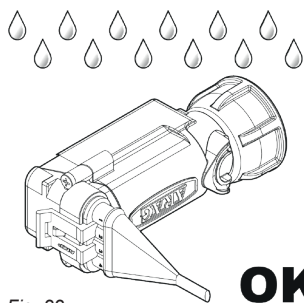
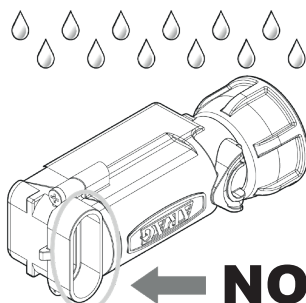

Fig. 22



**WARNING!**  
**DO NOT CONNECT THE SELETRON UNITS.**  
 THE SELETRON ELECTRIC CONNECTORS MUST BE CONNECTED AT A LATER TIME, DURING THE PAIRING PROCEDURE (chap. "13 Seletron connection" on page 61).

**WARNING:** TO AVOID DAMAGING ONE OR MORE DEVICES, MAKE SURE THAT NONE OF THE PARTS OF EACH SINGLE SELETRON (BODY, HARNESSSES, ETC.) COME INTO CONTACT WITH MOVING PARTS AT ANY TIME WHEN THE SYSTEM IS IN USE (INSTALLATION, COMMISSIONING, USE AND SHUTDOWN OF THE FARMING MACHINE).

Arag will not be held responsible for any damage to the system, people, animals or objects caused by failure to follow the guidelines outlined above.

6.4 Control unit valve connection

- The system only works if assembled with 3-wire type valves.
- Use ARAG valves: use of unsuitable valves not provided by ARAG automatically voids the warranty.
- ARAG is not liable for damage to the equipment, persons or animals caused by failure to observe the above instructions.
- All valve connectors must be provided with seals before being connected (Fig. 23).
- Make sure the seals are correctly fitted to avoid water infiltration when using the control unit.

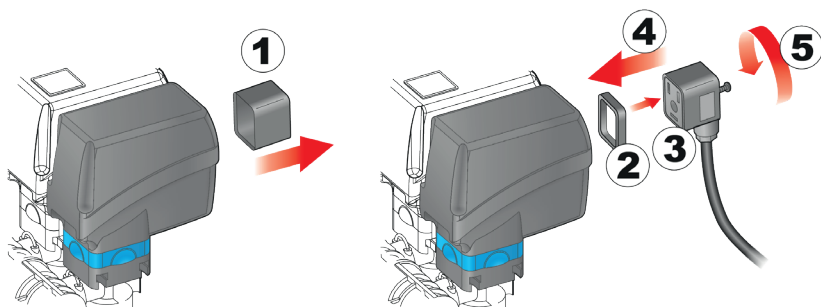

Fig. 23

Fix the connectors to the relevant valves according to the initials indicated in your assembly general diagram (par. 5.1 System recommended composition)

- Remove the protection cap (1, Fig. 23) from the electric valve.
- Place the seal (2) onto the connector (3), and push the connector fully on (4): **be careful not to bend the contacts upon insertion on the valve.**
- Tighten the screw (5) fully home.

**SECTION VALVES WITH CLASSIC INSTALLATION**

Connector 1 shall control the valve, which in turn is connected to the boom section 1, and so on with the other valves. Connect "connector 1" to "valve 1", and then the other connectors with increasing numbers from left to right: **the boom section 1 is the furthest from the machine on the left, looking at the machine from the rear side (Fig. 24).**

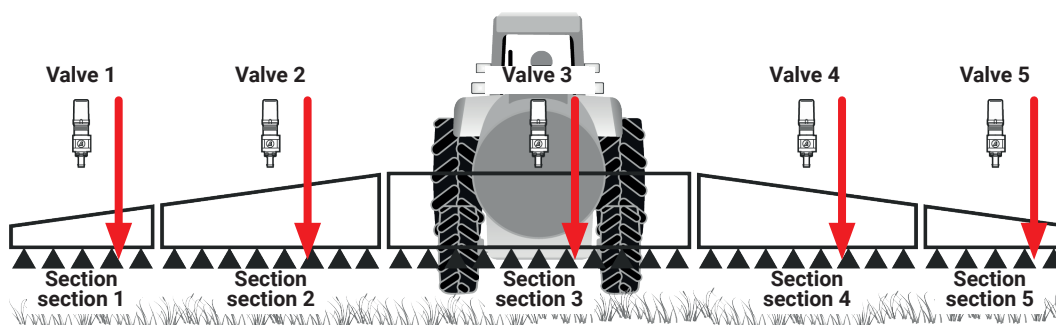

Fig. 24

**SECTION VALVES WITH DOUBLE BOOM**

This installation allows to pilot independently 2 booms with different nozzles and to choose automatically the nozzle or the combination of nozzles (A, B, A+B) according to the set pressure and application rate parameters.

Connectors 1 to 7 must be connected to the section valves of the first nozzle holder boom (A), while connectors 8 to 14 must be connected to the section valves of the second boom (B).

For all booms with a number of sections lower than 7, Fig. 25) connector 8 must ALWAYS pilot the valve connected to section 1 of the second boom (B): boom section 1 is the leftmost one when looking at the machine from behind.

The maximum number of section valves supported for nozzle holder boom A is 7.

The maximum number of section valves supported for nozzle holder boom B is 7.

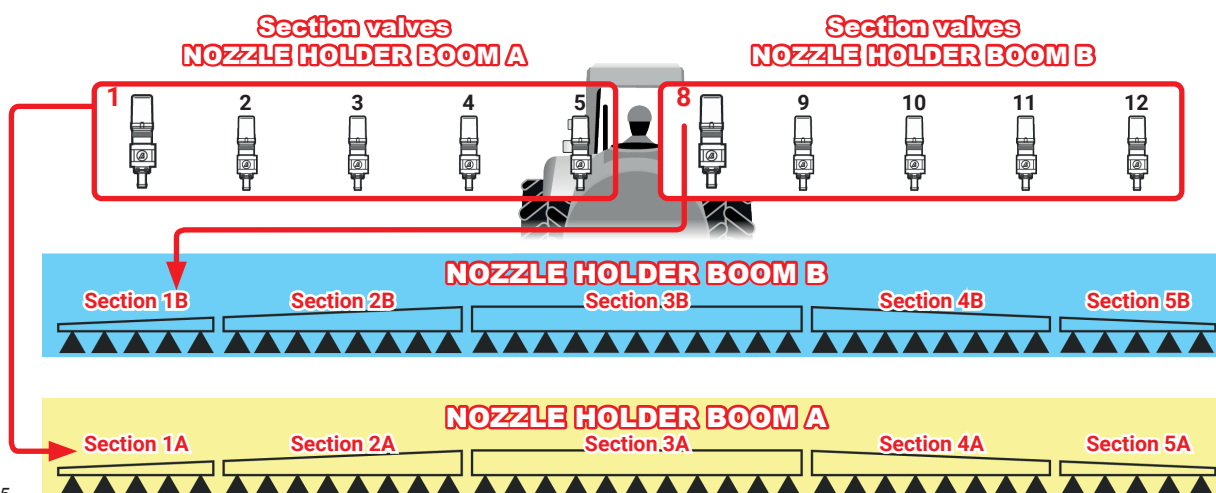

Fig. 25

**6.5 FENCE NOZZLE CONNECTION - Installation with section valves - Fig. 3**

The system allows two Seletron type valves to be connected to handle "Fence" type nozzles. The valves must be connected by means of an adapter cable.

**6.6 FENCE / BUFFER NOZZLE connection - Installation with Seletron system - Fig. 4**

The system allows two supplementary Seletron type valves to be connected to handle "Fence" or "Buffer" type nozzles.

**• FENCE NOZZLE:**

The Seletron installed must be a single type, regardless of what is mounted on the rest of the boom.

**• BUFFER NOZZLE:**

The Seletron and the nozzles installed must be of the same type as those mounted on the rest of the boom;

in particular, the end nozzles must be installed in the same position as the other nozzles and use the same flowrates.

Connect the Seletron nozzle holders to the ends of the boom using the appropriate splitter cable (21 Fig. 4), using the last connectors on the right and left of the main harness.

**6.7 Hydraulic valve connection**

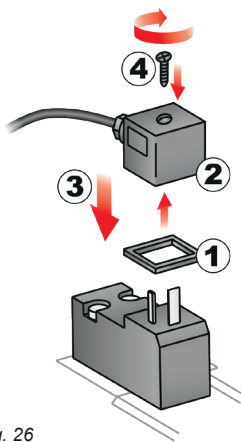

Fig. 26

The system can control up to 9 hydraulic functions through double action valves.

Fix the connectors to the relevant valves according to the initials indicated in your assembly general diagram (par. 5.1).

• Position seal (1) onto connector (2), then connect the latter pressing it fully home (3):

**during this operation, take special care not to bend valve electric contacts.**

• Insert screw inside connector, and screw it (4) until it is tightened.

The function of each switch on the hydraulic function control panel is described below.

• Connect the connector marked with "DD" to the pilot valve, and then the other connectors, as specified on the table:

CONTROL	MOVEMENT	CONNECTOR
Section movement 	Opening	1 ÷ 6a
	Closing	1 ÷ 6 C
Boom height 	Opening	AA
	Closing	AC
Boom lock 	Opening	BA
	Closing	BC
Boom leveling 	Opening	CA
	Closing	CC

6.8 Sensor connection

Fix the connectors to the relevant functions according to the initials indicated in your assembly general diagram (par. 5.1).

**Harness cables are marked with a symbol denoting their functions: please see the table for correct harness connection.**



**Use ARAG sensors: use of unsuitable sensors not provided by ARAG automatically voids the warranty. ARAG is not liable for damage to the equipment, persons or animals caused by failure to observe the above instructions.**

ITEM	CONNECTION
<b>F</b>	Flowmeter
<b>L</b>	Level sensor
<b>M</b>	Pressure sensor
<b>S</b>	Speed sensor
<b>T</b>	Filling flowmeter
<b>X</b>	RPM sensor
<b>Z</b>	Boom lighting / flashing

- The products are supplied with the sensor installation instructions.

The following speed sensors can also be used as RPM sensors:

- inductive speed sensor (**code 467100.086**);
- magnetic speed sensor (**code 467100.100**).

- Connection of:

- flowmeter;
- pressure sensor;
- level sensor;
- filling flowmeter;
- RPM sensor.

All ARAG sensors use the same type of connector. Connect the sensor connector to the relevant harness; make sure it is correctly fitted and push it until locking it.



Fig. 27



Fig. 28



## 7 ISOBUS SYSTEM CABLE CONNECTION

1. Connect the ISOBUS and IN-CAB cables.
2. Turn the VT on.
3. Wait for the OP complete loading (par. 8.1).

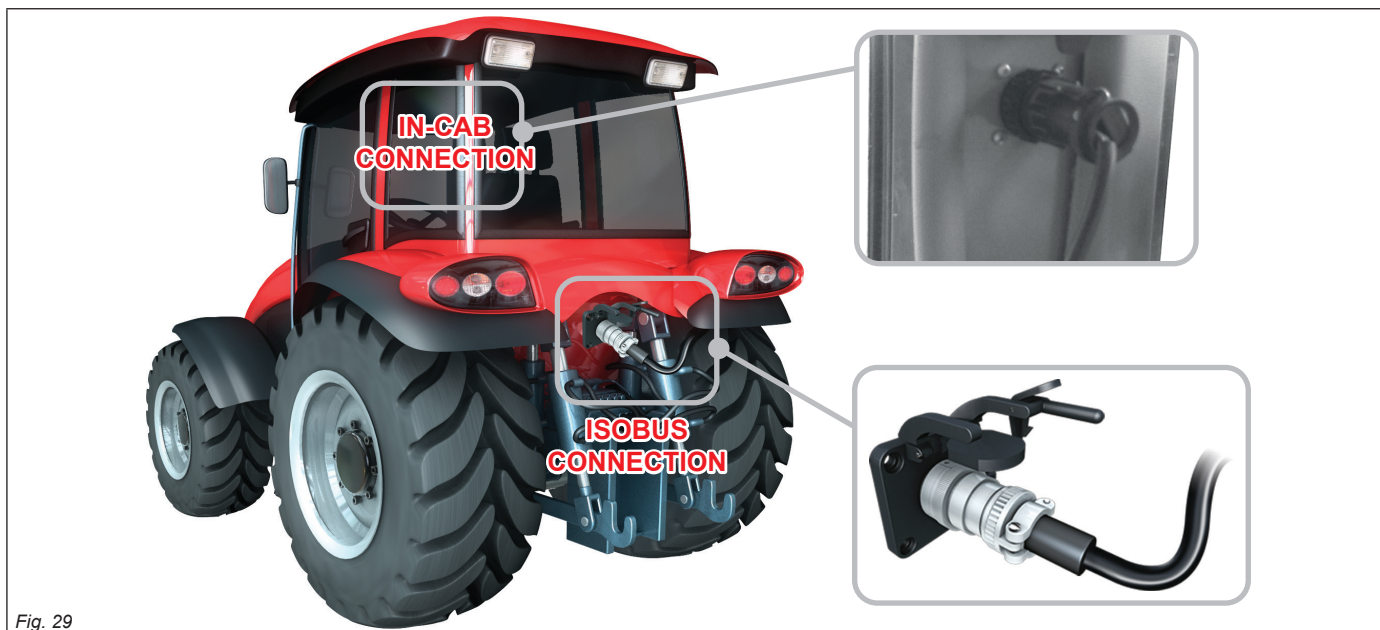

Fig. 29

### 7.1 Connection of in-cab cable

Use the cable supplied in the auxiliary input package\*.

**Connection:** Fit the connectors (**in-cab connection** in Fig. 29), ensure they are correctly in place and turn the ring nut clockwise until blocking them.

*\*ARAG Auxiliary Input control system is not compulsory on all systems, and must thus be ordered separately.  
Some VTs allow controlling section valves directly from monitor touch-screen panel.*

### 7.2 Connection of ISOBUS cable

Use the cable "IBX100 connection cable, tractor (ISOBUS PLUG)" (Fig. 2 / Fig. 3 / Fig. 4 par. 5.1 System recommended composition).

**Connections:** fix the connectors (**ISOBUS connection** in Fig. 29); make sure they are correctly fitted and push until locking them.

## 8 FOREWORD



Images and the relevant description texts contained in this manual are given as a reference as they can vary depending on the VT used. If the descriptions do not correspond to the text displayed in your VT, refer to the manual attached to the latter.

### 8.1 "OBJECT POOL" loading

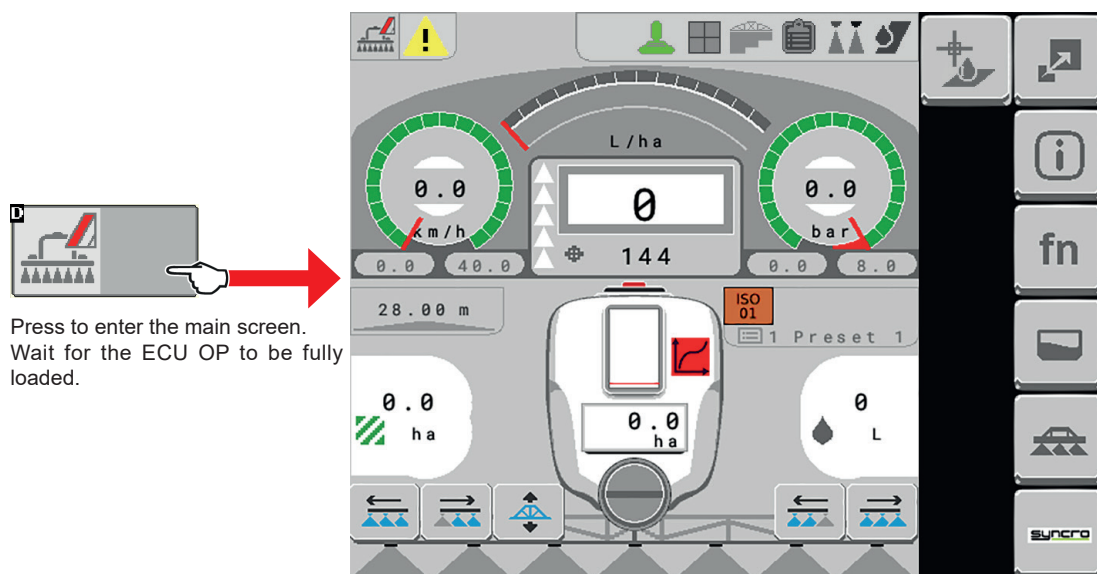
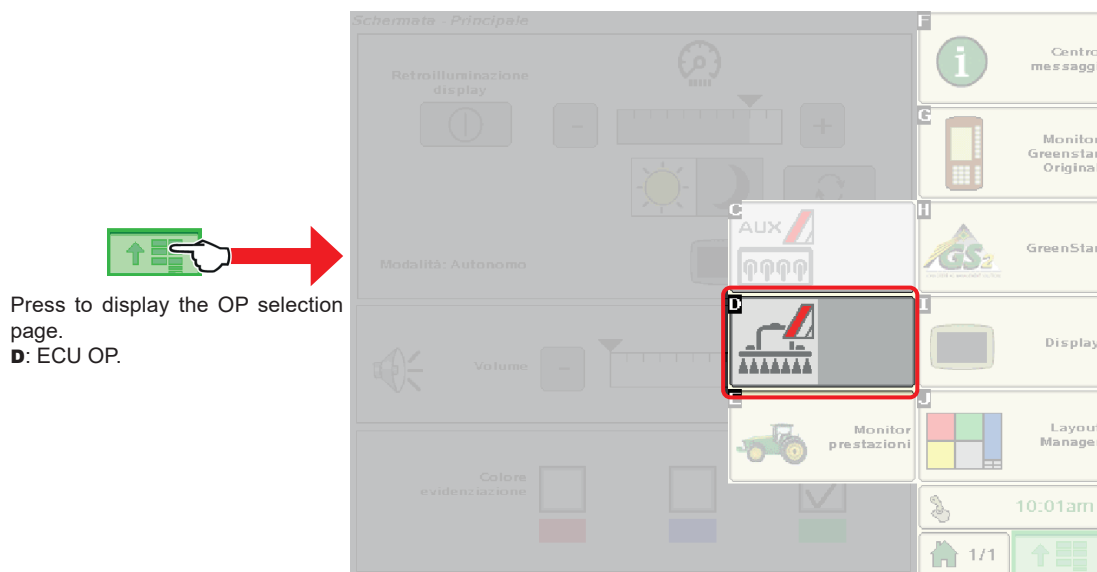

### 8.2 Loading of "Second Sprayer OBJECT POOL"

The OBJECT POOL indexed with the number **2** for the second IBX100 Sprayer control unit will be loaded.



This icon will allow managing the OP and therefore the second Sprayer control unit independently from the first one.

This new function meets the need of managing two IBX devices of the same type on the same tool. To connect the second IBX100 Sprayer2 to the system, please contact Arag Technical Assistance.

## 9 SETTING

### 9.1 Tests and checks before setting

Before setup, check:

- that all components are correctly installed;
- the correct connection to the power source;
- the component connection.



Failure to correctly connect system components or to use specified components might damage the device or its components.

### 9.2 Control layout

#### MENU / DATA SELECTION

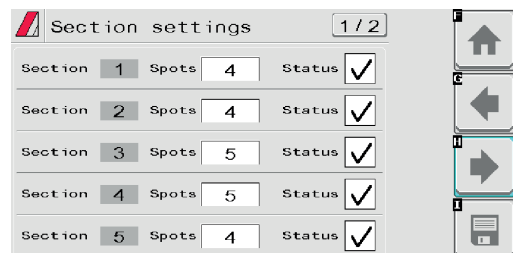

Fig. 30



Goes back to main screen



Goes back to previous menu, or scrolls the pages of a menu (previous page)



Scrolls the pages of a menu (next page)



Saves the changes to current page

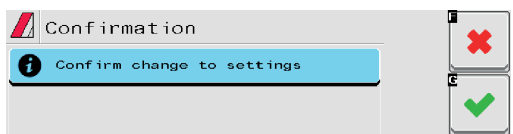

Fig. 31



Quits without confirming the changes



Saves the changes

#### ENTERING A NUMERICAL VALUE

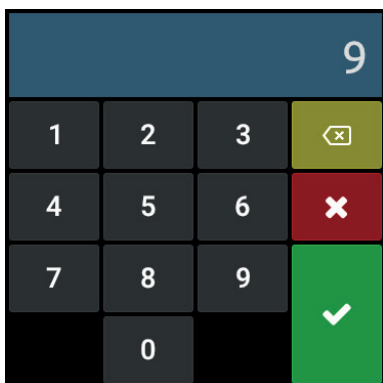

Fig. 32



Cancel



Exits



Confirm

The numeric keypad's interface depends on the Virtual Terminal used.

10 IMPLEMENT SETTINGS > BASIC SETTINGS



Fig. 33

Upon first switching on, enter the device basic settings.  
For a correct use of the keys during setting, refer to par. 9.2.

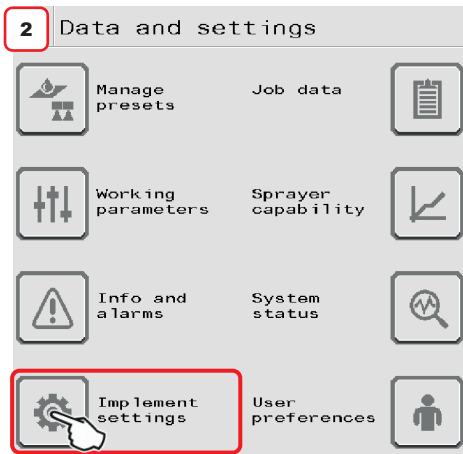

Fig. 34



Fig. 35

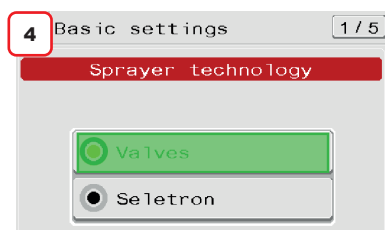

Fig. 36

**BASIC SETTING PROCEDURE START**

- VT will guide you during the configuration: follow the steps and select the desired options.
- ◀ previous step; ▶ next step
- When the message **Confirm change to settings** appears, the configuration is complete.
- Press .

**BASIC SETTINGS MENU**

• **Sprayer technology**

**Valves:** system with electrically-activated valves - with gearmotor

**Seletron:** system with Seletron valves.

• **Rate control type:** indicate the actuator used by the system to adjust the amount of product, intended for the boom, needed to achieve the application rate set by the user.

**Electric prop. valve:** select this option when there is an electric motorized proportional valve installed in the system that regulates the increase or decrease in product quantity.

**Pump control:** select this option when adjustment of the amount of product is made by acting directly on the rotation speed of a centrifugal pump. In this case, the IBX100 system is able to control in PWM (Pulse Width Modulation) a hydraulic proportional valve that adjusts the amount of oil to be sent to the pump so as to increase or decrease its rotation speed.

• **Main valve type:** type of main control valve installed on the control unit.

**None**

**2 Ways** (drain valve)

**3 Ways** (main valve).

• **Boom settings:** nozzle holder boom type (system with section valves).

**Single** (single boom)

**Double** (double boom).

• **Spraying spot type:** type of Seletron (system with Seletron).

**1** single

**2** twin

**4** fourfold.

• **Flowrate reference sensor:** device used to calculate flowrate.

**Flowmeter:** the measured flowrate is used for the application rate regulation.

**Pressure sensor:** the measured pressure is used for application rate regulation.

**Both:** the application rate is regulated using the flowmeter, when the working flowrate is within its reading range; outside the flowmeter reading range the system uses the installed pressure sensor.

• **Terminal nozzle type**

**None**

**Buffer zone:** allows enabling the use of nozzles at the "Buffer zone" see par. 17.1 (ONLY FOR SELETRON SYSTEM)

**"Fence":** allows using the "Fence" nozzles, see par. 17.1

• **Tank level source:** indicate the method used to measure the amount of product in the tank.

**Manual:** select this option when there is no sensor in the system to measure the amount of product available in the tank. The operator must manually enter the value of the quantity loaded into the tank. During treatment, the IBX100 system will automatically calculate the amount of product distributed and subtract it from the amount previously entered, returning an indication of the residue in the tank.

**Filling flowmeter:** select this option when a flowmeter that measures the amount of product loaded into the tank is installed in the system. During treatment, the IBX100 system will automatically calculate the amount of product distributed and subtract it from the amount in the tank to have an indication of the residue in the tank.

**Single tank level:** select this option when a level sensor is installed in the system to measure the amount of product loaded into the tank. During treatment, the sensor measures the amount of product in the tank in real time.

By selecting this option in the HOME page, this icon  will be displayed on the tank.

The icon with red background indicates that NO calibration curve is present.

Par. 11.10.3 on page 34 includes the instructions to create it; when the calibration curve is present, the red icon will disappear.

**Dual tank level:** select this option when there are two tanks in the system and a level sensor is installed for each of them.

Each sensor measures in real time the amount of product in the tank on which it is installed.

By selecting this option another tank will be displayed alongside the first one with this icon .

The icon with red background indicates that NO calibration curve is present.

It is not possible to create a calibration curve for tank 2, you can only transfer the calibration curve via VT with FileServer (par. 11.10.5 on page 36) or Visio Isobus functions. If the calibration curve is present the red icon will disappear.

---

**BASIC SETUP PROCEDURE IS NOW COMPLETE: WHEN RETURNING TO THE HOME PAGE, THE SYSTEM RESTARTS AUTOMATICALLY.  
NOW IT IS POSSIBLE TO START THE ADVANCED SETUP PROCEDURE, DESCRIBED IN CHAP. 11.**

**11 IMPLEMENT SETTINGS > ADVANCED SETUP**

The computer can be set-up with all the data required to ensure a correct distribution of the treatment product.



**THE BASIC SETTINGS (CHAP. 10) AFFECT WHICH AND HOW MENU ITEMS ARE DISPLAYED, HENCE WHICH ADVANCED SETTING IT IS POSSIBLE TO CONTROL. A NAVIGATION SUMMARY IS AVAILABLE IN FIG. 38.**

This operation must be done once only, when installing the computer.

**ACCESS TO IMPLEMENT SETTINGS MENU**

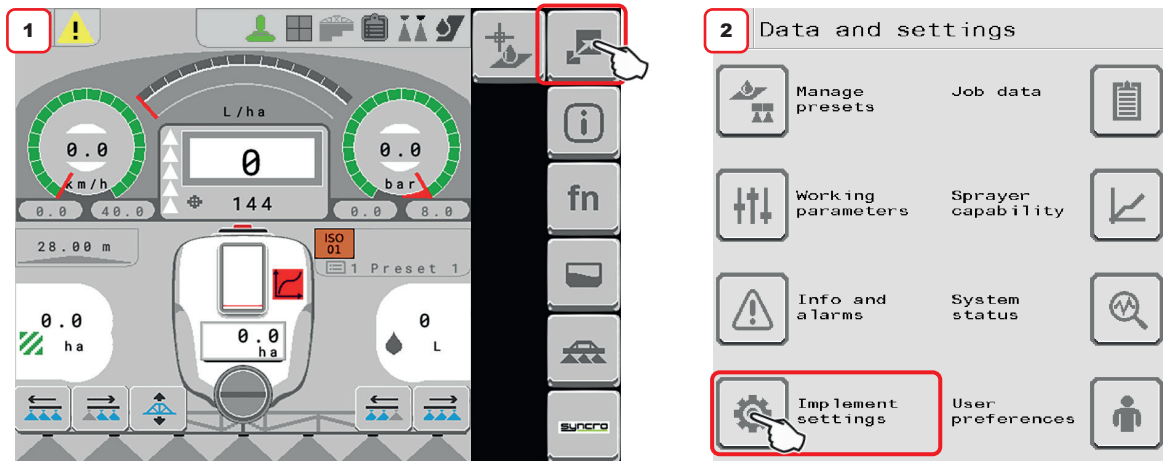

Fig. 37

**STRUCTURE OF THE IMPLEMENT SETTINGS MENU**

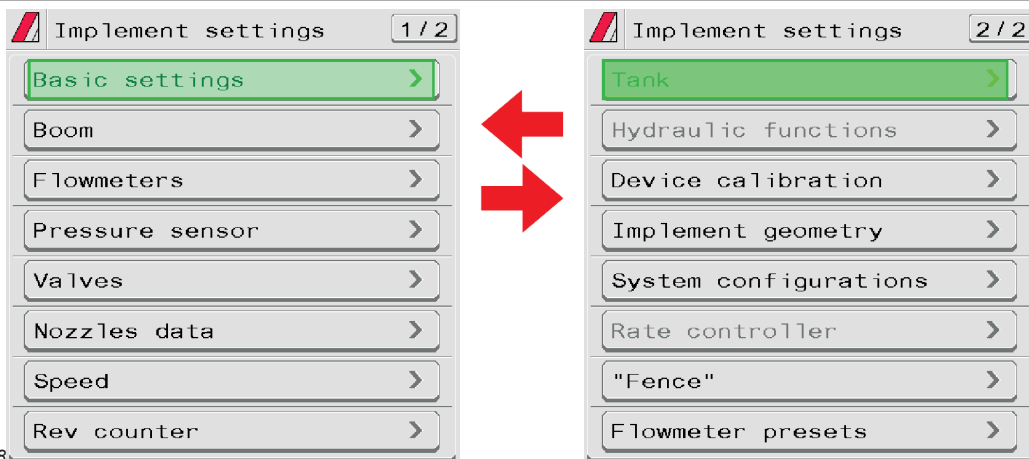

Fig. 38  
Fig. 39



The gray items cannot be edited.  
For a correct use of the keys during setting, refer to par. 9.2.

	Goes back to main screen		Goes back to previous menu, or scrolls the pages of a menu (previous page)		Quits without confirming the changes
	Saves the changes to current page		Scrolls the pages of a menu (next page)		Saves the changes

11.1 Home > data and settings > implement settings > Boom

- 1 Indicate the number of boom sections.
- 2 Indicate the distance between spraying points (nozzle holders).
- 3 Indicate the number of spraying points (nozzle holders) installed on each boom section.
  - 3a Repeat the setup for each section (Fig. 41).
  - 3b It allows to enable/disable specific boom sections. Repeat the setup for each section, by disabling the disconnected outputs.
- 4 The displayed number of valves / Seletron that can be managed depends on the type of VT connected to the system. The VT could be able to manage just a limited number of sections, therefore, should it not be possible to manage all nozzle holders individually, the VT will group them so as to fully exploit the number of permitted sections.
- 5 Displays the terminal nozzle type (basic settings, chap. 10).

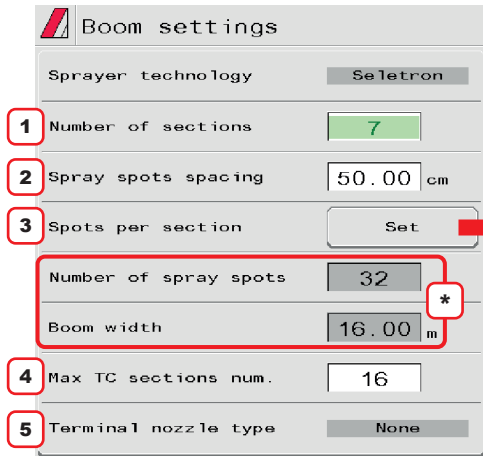

Fig. 40

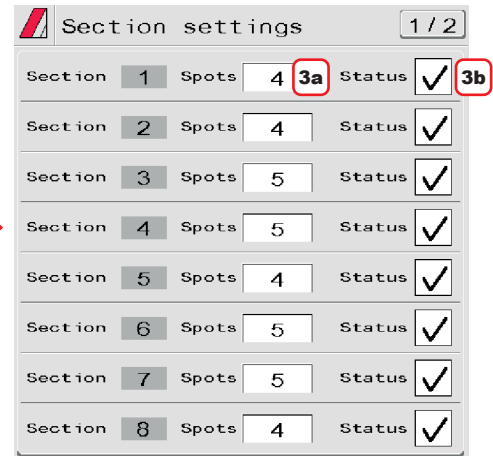

Fig. 41

\* Depending on your programming, both the total number of spraying points and the boom width value will change, displayed in Fig. 40.

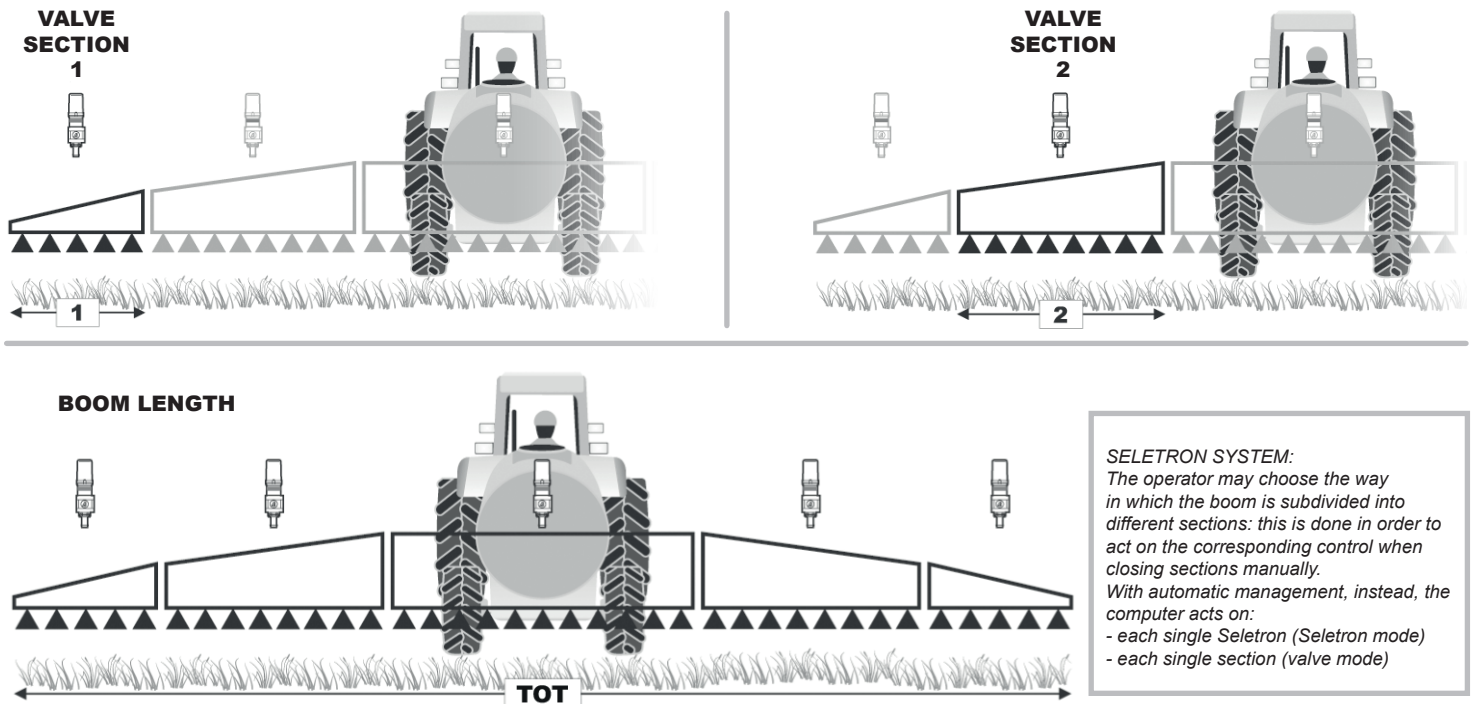

Fig. 42

	Goes back to main screen		Goes back to previous menu, or scrolls the pages of a menu (previous page)		Quits without confirming the changes
	Saves the changes to current page		Scrolls the pages of a menu (next page)		Saves the changes

11.2 Home > data and settings > implement settings > Flowmeters

This menu allows setting both flowmeter and filling flowmeter (if set).

- 1 Set installed flowmeter by selecting it from the list in Fig. 44 (use keys 2 to scroll items, and key 3 to confirm).
- 4 Set the Constant.



The items Minimum flowrate and Maximum flowrate can be modified only when the option Other is enabled.

- \* Use keys H and G to move between the pages Flowmeter (Fig. 43) and Filling flowmeter (Fig. 45).

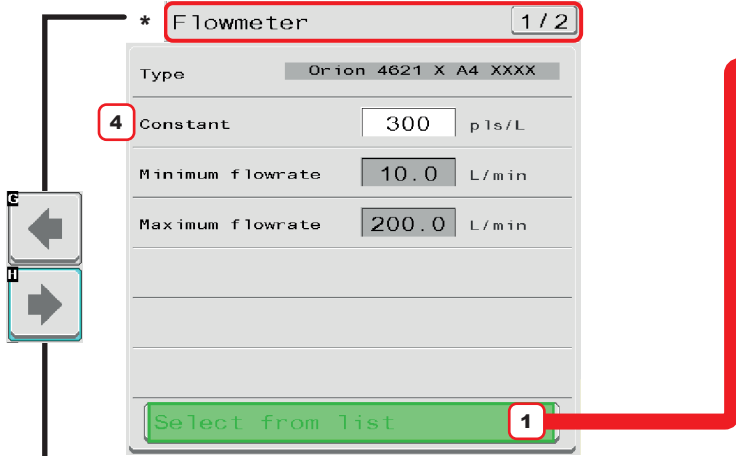

Fig. 43

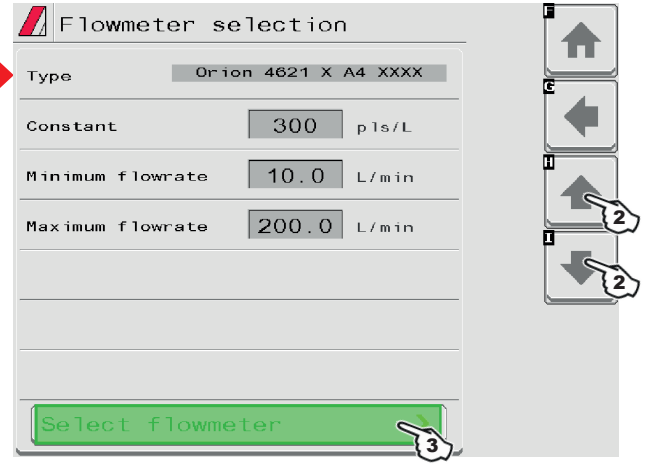

Fig. 44

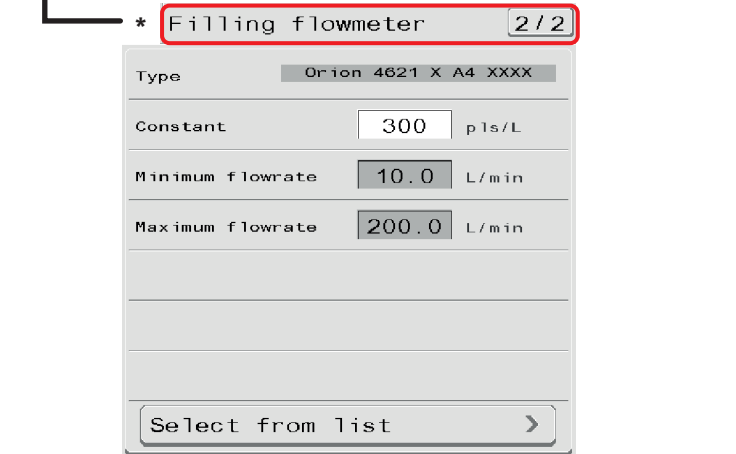

Fig. 45

List of available flowmeters and preset data:

**ORION FLOWMETERS**

Type	Constant		Minimum flowrate		Maximum flowrate	
	pIs/l	pIs/gal	l/min	GPM	l/min	GPM
4621 x A0 xxxx	6000	22710	0.5	0.10	10	2.6
4621 x A1 xxxx	3000	11355	1	0.30	20	5.3
4621 x A2 xxxx	1200	4542	2.5	0.70	50	13.2
4621 x A3 xxxx	600	2271	5	1.30	100	26.4
462x x A4 xxxx	300	1135	10	2.60	200	52.8
4622 x A5 xxxx	150	568	20	5.30	400	105.7
4622 x A6 xxxx	100	378	30	7.90	600	158.5

**WOLF FLOWMETERS**

Type	Constant		Minimum flowrate		Maximum flowrate	
	pIs/l	pIs/gal	l/min	GPM	l/min	GPM
462 x 2 xxx	1025	3880	2.5	0.7	50	13.2
462 x 3 xxx	625	2366	5.0	1.3	100	26.4
462 x 4 xxx	250	946	10.0	2.6	200	52.8
462 x 5 xxx	132	500	20.0	5.3	400	105.7
462 x 7 xxx	60	227	40.0	10.6	800	211.3

**ORION WR FLOWMETERS**

Type	Constant		Minimum flowrate		Maximum flowrate	
	pIs/l	pIs/gal	l/min	GPM	l/min	GPM
Other	625	2366	10	2.60	200	52.8

Type	Constant		Minimum flowrate		Maximum flowrate	
	pIs/l	pIs/gal	l/min	GPM	l/min	GPM
462W100	6000	22710	0.3	0.08	100	26.4
462W200	3000	11355	0.5	0.13	200	52.8



11.3 Home > data and settings > implement settings > Pressure sensor

- 1 Set installed pressure sensor by selecting it from the list in Fig. 47 (use keys 2 to scroll items, and key 3 to confirm).
- The relevant configuration data will be automatically loaded (Fig. 46).
- 4 Activate pressure sensor.



Item Maximum pressure can be edited only when option USER is enabled.

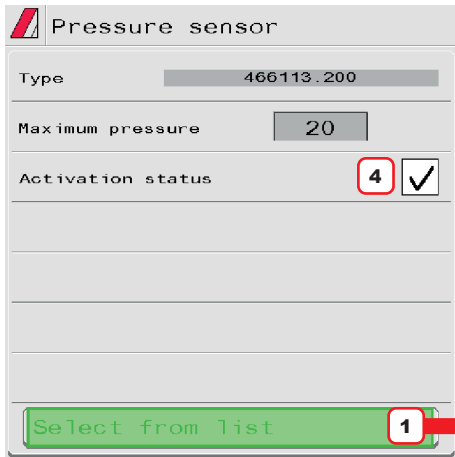

Fig. 46

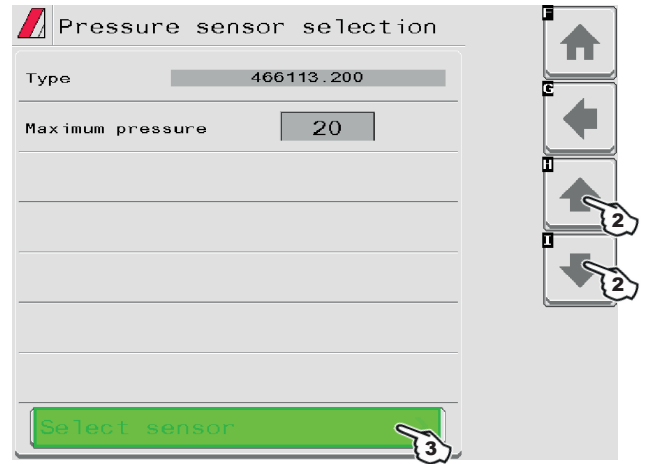

Fig. 47

Depending on the basic settings (**Flowrate reference sensor**, par. 10), the pressure sensor, once properly set up, can perform different functions:

- **Pressure sensor:** the pressure measured by the sensor is used to adjust the application rate.
- **Flowmeter:** the pressure sensor displays ONLY the job pressure.
- **Both:** the pressure sensor displays the job pressure when the machine works within the flowmeter limits. When the flowmeter operates outside the limits the pressure measured by the sensor is used to adjust the application rate.

The table below indicates the values that are automatically set selecting the sensor code. If the installed sensor is not displayed, select **USER** and enter the relevant values.

ARAG PRESSURE SENSOR		
Type	Maximum pressure	
	bar	PSI
466113.200	20.0	290
466113.500	50.0	725
USER	20.0	290

	Goes back to main screen		Goes back to previous menu, or scrolls the pages of a menu (previous page)		Quits without confirming the changes
	Saves the changes to current page		Scrolls the pages of a menu (next page)		Saves the changes

11.4 Home > data and settings > implement settings > Valves

It allows configuring the main valve, the pressure control valve and the section valves:

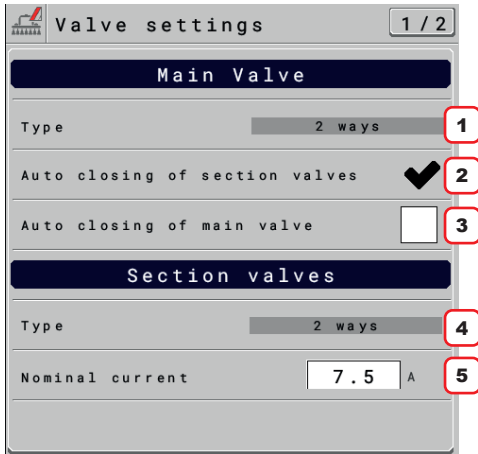

Fig. 48

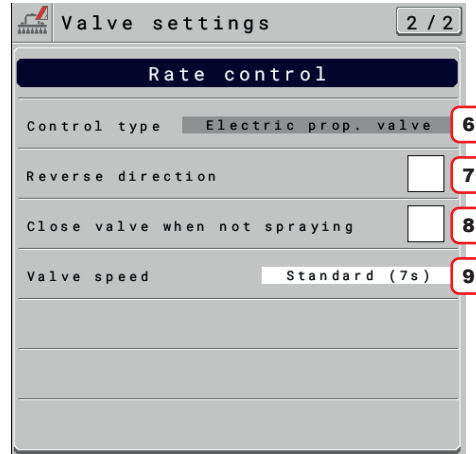

Fig. 49

**1 Main Valve > Type**

Main control valve installed. Available options are: **None**, **2 ways** (drain valve), **3 ways** (main valve).  
*Item Main valve > Type is shown as a REMINDER: it is activated during the guided setup (par. 10). It can not therefore be modified on this screen.*

**2 Main Valve > Auto closing of section valves**

Allows to enable/disable the section automatic closing when the main control valve is closed.  
 On a Seletron system, auto closing of section valves is active by default ("**M**" type).

• "**M**" operating mode ( option  ):

the section valves are closed or opened by operating the main control valve based on the settings of the controls relating to the single section valves, namely:

- if section controls are set to OFF, when main control is operated, the sections will stay closed;
- if the control of one or more section valves is set to ON, when main valve is closed or opened, the section valves will be closed or opened as well.

**ENABLED MODE CAN NOT BE MODIFIED:**  
 this condition occurs when no main valve is installed on the system or the one installed is a 2-way valve.

• "**P**" operating mode (option  ):

the section valves are controlled independently.  
 Main valve control functions do not affect section valve opening or closing.

**3 Main Valve > auto closing of main valve**

When all section valves are closed and this option is enabled, the main valve is automatically closed as well.

Main valve automatic closure enabled /  Main valve automatic closure disabled).

**ENABLED MODE CAN NOT BE MODIFIED:**  
 this condition occurs when no main valve is installed on the system.

**4 Section valves > Type**

Indicate the type of installed section valves. Available options are:

- **2 ways** (valves without metered by-pass)
- **3 ways** (valves with metered by-passes)

*On a Seletron system, section valves are of the 2 ways type (without metered by-passes) and are automatically set.*

**5 Section valves > Nominal current.**

*FOR SELETRON SYSTEMS, ONLY*

This is the maximum admissible current value for each SELETRON line.

**6 Rate control > Control type.**

Read-only item. The rate control type was preset earlier in chapter 10 on page 24.

**Electric prop. valve / Pump control**

**6 Rate control > Reverse direction**

Indicate the type of installed control valve. Available options are:

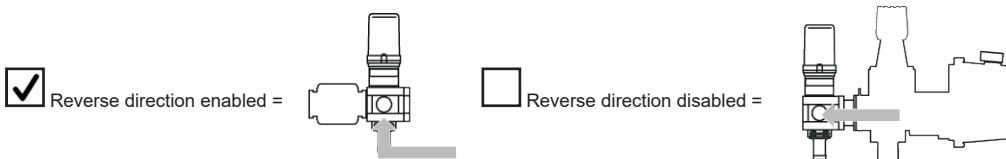

**7 Rate control > Close valve when not spraying**

It allows controlling a regulating valve, which must be closed when stopping the product output.

**8 Rate control > Valve speed**

Standard 7s / Fast 3.5s / Ultra-fast 2s.

11.5 Home > data and settings > implement settings > Nozzle data

It allows setting the characteristic data of 12 ISO and 6 “User” (A ÷ F) nozzle types.

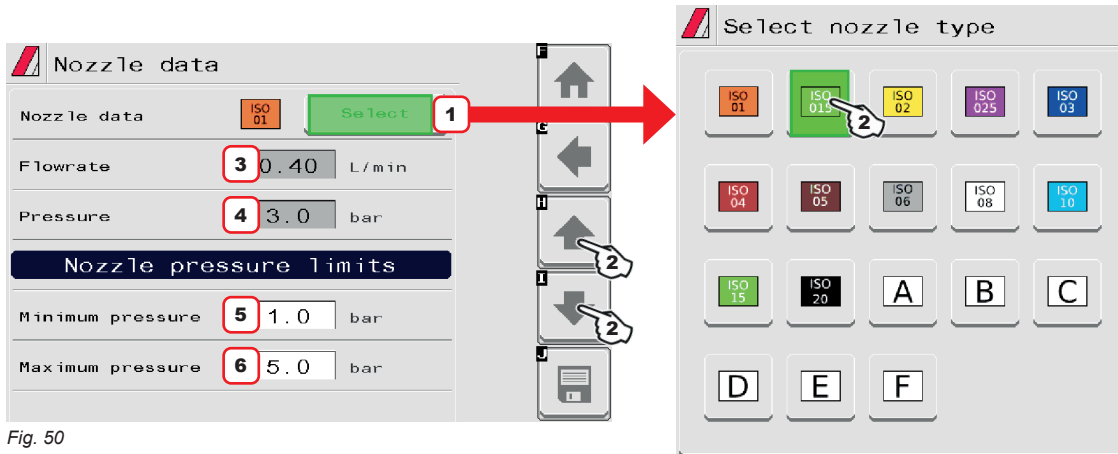

Fig. 50

Fig. 51

- 1 - 2 Select the nozzle to be set (Fig. 50 / Fig. 51); enter the characteristics (Fig. 50).  
If necessary, repeat the setup for each nozzle.
- 3 - 4 Set the reference flowrate and pressure for the selected nozzle.  
The flowrate of the nozzle being used allows IBX100 to calculate the pressure without a pressure sensor.  
*The values for Flowrate and Pressure can be modified for “User” nozzles ONLY, not for ISO nozzles.*
- 5 - 6 Set the pressure limits for the selected nozzle.  
Enable the proper function in the menu **Info and alarms** (par. 12.3) if you want the computer to trigger an alarm when the nozzle is outside the set range.  
*For the procedure to be followed when an alarm occurs, please refer to par. 18.3.*

When using an implement with or twin or fourfold Seletron technology or a sprayer with dual boom valve technology, it is possible to customize the selection of the pressure at which to change nozzle or nozzle combination based on the pressure values for the selected nozzles.

When setting a spraying, make sure to couple compatible nozzles.  
For example:

- Compatible nozzles: the flowrate at 1 bar of the ISO025 nozzle is LOWER than the flowrate at 5 bars of the ISO02 nozzle (Fig. 140).
  - NON-compatible nozzles: the flowrate at 1 bar of the ISO05 nozzle is HIGHER than the flowrate at 5 bars of the ISO02 nozzle (Fig. 141).
- In the same way, the overall flowrate of both nozzles at MINIMUM pressure shall be LOWER than the flowrate of the high flowrate nozzle at MAXIMUM pressure.

E.g. Fig. 140 and Fig. 141

The **Sprayer capability > Nozzles configuration** menu allows verifying that the settings for the selected nozzle have been made correctly . If there are errors in the configuration the device shows this symbol .

	Goes back to main screen		Goes back to previous menu, or scrolls the pages of a menu (previous page)		Quits without confirming the changes
	Saves the changes to current page		Scrolls the pages of a menu (next page)		Saves the changes

11.6 Home > data and settings > implement settings > Speed

**Speed settings:** allows setting the speed data.

1 It allows selecting the source for speed calculation.

Available options:

• **Wheel sensor (ECU):** when this option is enabled, speed is calculated through the pulses coming from the speed sensor, installed on the wheel **and connected to the ECU through proper harness**. The wheel constant must be entered during the setup procedure.

• **\*Tractor wheel** [PGN65096]: the IBX100 control unit receives the vehicle driving speed via the ISOBUS line. The speed value is provided by the Tractor-ECU according to the rotation speed of the wheel or a mechanical part of the tractor.

*NOTE: Tractor-ECU can be a standard ECU in the ISOBUS tractor, installed by after-sales service (ARAG IBX20 TECU) or emulated by the VT in the cabin.*

• **\*Tractor radar** [PGN65097]: the IBX100 control unit receives the vehicle driving speed via the ISOBUS line. The speed value is provided by the Tractor-ECU that detects the data sent by the radar installed on the tractor.

*NOTE: Tractor-ECU can be a standard ECU in the ISOBUS tractor, installed by the after-sales service (ARAG IBX20 TECU) or emulated by the VT in the cabin.*

• **Simulated speed:** allows enabling speed simulation in order to carry out adjustment tests even when the machine is stationary.

• **GPS NMEA2000** [PGN129026]: the speed value is provided, via the ISOBUS communication line, in GPS NMEA2000 data format.

• **Tractor GNSS** [PGN65256]: the IBX100 control unit receives the vehicle driving speed via the ISOBUS line. The speed value is provided by a GNSS device.



**\* several systems use these messages to transmit the speed data of the vehicle detected by the GPS receiver installed in the system to all devices connected on the ISOBUS line.**

2 Enter the wheel constant value calculated with the suitable formula.

3 Enter the simulated speed value.

The wheel constant can be calculated with a good approximation by detecting the distance traveled by the wheel with the speed sensor. The longer the distance traveled, the more accurate the wheel constant calculation.

$$K_{wheel} = \frac{\text{distance traveled (cm)}}{\text{no. of detection points} \times \text{wheel rpm}}$$

**<distance traveled>** distance expressed in cm covered by the wheel along measurement travel.

**<no. of measurement points>** number of measurement points (e.g., magnets, bolts, etc.), mounted on wheel.

**<no. of wheel revolutions>** number of wheel revolutions required to travel measurement distance.



**Take measurements with tires at the operating pressure. This test must be performed on medium-hard terrain; for application to very soft or very hard terrain, rolling diameter may vary, leading to inaccurate output calculation; when this is the case, repeat the procedure. During the test, cover the distance with the tank filled up to half capacity with water.**

Fig. 52

11.7 Home > data and settings > implement settings > Rev counter

1 It allows enabling/disabling the rev counter status ( rev counter enabled /  rev counter disabled).

2 Indicate the constant of the installed rev counter.

3 - 4 Enable the appropriate function of the **Info and alarms** menu (par. 12.3) if you want the VT to generate an alarm when, during spraying, the measured RPM are outside the set range. For minimum speed, the control is active only when the spraying is active (**main switch ON**). *For the procedure to be followed when an alarm occurs, please refer to par. 18.3.*

5 Real-time displaying of the actual datum.

Fig. 53

11.8 Home > data and settings > implement settings > Tank

Allows setting the tank values:

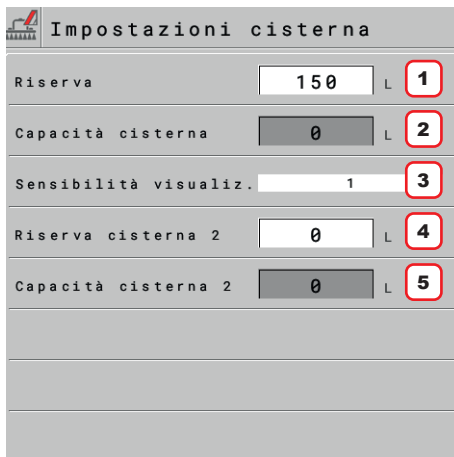

Fig. 54

**1** Indicate the reserve value under which the alarm is triggered.  
The tank alarm is triggered when, during spraying, the tank level falls below the set value (enable the appropriate function in the **Info and alarms** menu, par. 12.3).  
*For the procedure to be followed when an alarm occurs, please refer to par. 18.3.*

**2** Indicate tank capacity.  
**WHEN THE VALUE IS ON GRAY BACKGROUND, IT CANNOT BE CHANGED.** In this case the level sensor is installed and a tank profile is present in the IBX100 or a tank calibration is required.

**3** Select the tank volume display step from those proposed: **1 / 5 / 10 / 25 / 50 / 100.**  
The **Sensitivity display** is **ONLY** present when entering in **Home > Data and settings > Implement settings > Basic settings > Tank level source > Single tank level**

**4** Indicate the tank 2 reserve value under which the alarm is triggered.  
The tank alarm 2 is triggered when, during spraying, the tank level falls below the set value (enable the appropriate function in the **Info and alarms** menu, par. 12.3).  
*For the procedure to be followed when an alarm occurs, please refer to par. 18.3.*

**5** Indicate tank 2 capacity.  
**WHEN THE VALUE IS ON GRAY BACKGROUND, IT CANNOT BE CHANGED.** In this case the level sensor is installed and a tank profile is present in the IBX100.  
*The system allows displaying the status of another tank if another level sensor is installed (par. 19.4).*



Goes back to main screen



Goes back to previous menu, or scrolls the pages of a menu (previous page)



Quits without confirming the changes



Saves the changes to current page



Scrolls the pages of a menu (next page)



Saves the changes

11.9 Home > Data and settings > Implement settings > Hydraulic functions

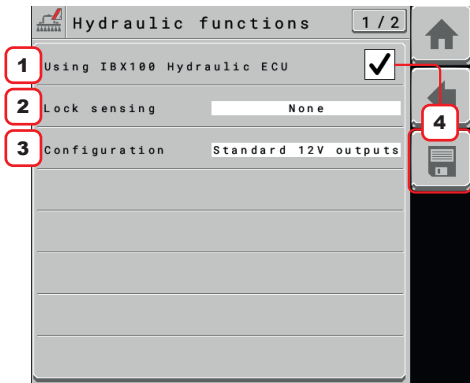

Fig. 55

- 1 Select this option when an ARAG IBX100 ISOBUS HYDRAULIC control unit is installed to manage hydraulic functions. This option will allow:
  - treatment status information to be transferred to the IBX100 Hydraulic Isobus.
  - boom locking cylinder status information to be transferred to the IBX100 Hydraulic Isobus (if there is a sensor in the system to detect it).



**WARNING: function available on IBX100 Hydraulic Isobus Arag from SW versions newer than 1.3.X;**

**WARNING: by enabling this checkbox, page 4 (2/2) will no longer be available.**

- 2 Select this option if the boom lock status detection sensor has been installed in the system.
  - **LOCK = Switch open:** the installed boom lock detection sensor closes the contact when the boom is unlocked.
  - **LOCK = Switch closed:** the installed boom lock detection sensor closes the contact when the boom is locked.

The following symbols appear on the Home screen

- **None:** System with no sensor for detecting boom lock status.

- 3 Select the control mode of the hydraulic outputs installed on the farming machine:
  - **Standard 12V outputs:** all hydraulic outputs, including the output that controls the pilot valve, are configured to control ON-OFF hydraulic valves.
  - **PWM flow control:** all hydraulic outputs are configured to control ON-OFF valves, with the exception of one output (connector 2A and 2C wiring 7 functions and connector 3A and 3C wiring 9 functions) configured to control a hydraulic proportional valve in PWM. This PWM output will come into operation when one of the ON-OFF outputs is activated.



**Function ONLY available with the system configured in mode "Section valves" and System configurations > Auxiliary inputs > Hyd 7 / 9 (par. 15.5).**

- **Quad PWM output:**

- wiring 7 functions: the outputs corresponding to TILT (CA and CC connectors), LIFT (AA and AC connectors), 2 (2A and 2C connectors) and 3 (3A and 3C connectors) will be configured to control in PWM respective proportional hydraulic valves
  - wiring 9 functions: the outputs corresponding to TILT (CA and CC connectors), LIFT (AA and AC connectors), 3 (3A and 3C connectors) and 4 (4A and 4C connectors) will be configured to control in PWM respective proportional hydraulic valves
- All remaining outputs will be configured to control ON-OFF hydraulic valves.



**Function ONLY available with the system configured in mode "Section valves" and System configurations > Auxiliary inputs > Hyd 7 / 9 (par. 15.5).**

- 4 Press the right arrow button to access the hydraulic function configuration pages. Scroll through the function pages with the up and down arrows.
- 5 Operating a hydraulic function on IBX100 ISOBUS SPRAYER activates the hydraulic valve related to that movement along with the pilot valve (DD). Selecting functions on this page deactivates the pilot valve (DD) control for the selected hydraulic function.
- 6 Select the hydraulic functions that are to be controlled with switch latching functions. The related switch will have 2 positions.
- 7 It allows multiple boom movements to be grouped into one control: FN1.
- 8 It allows multiple boom movements to be grouped into one control: FN2.

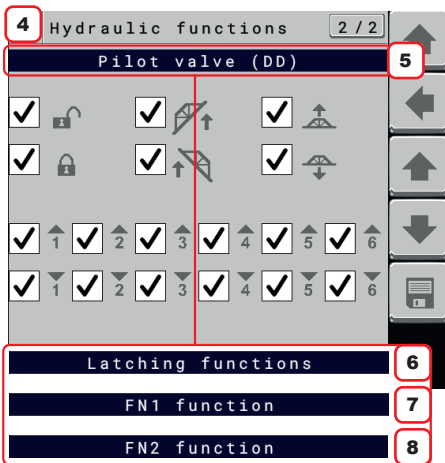
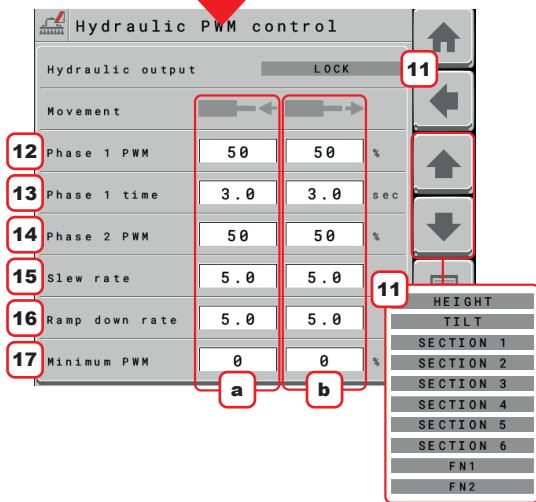
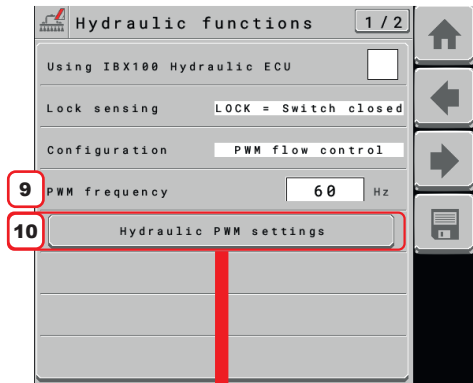

Fig. 56

	Goes back to main screen		Goes back to previous menu, or scrolls the pages of a menu (previous page)		Quits without confirming the changes
	Saves the changes to current page		Scrolls the pages of a menu (next page)		Saves the changes



All of the following points will be available ONLY with the system in PWM flow control mode or Quad PWM output mode.



**9** Enter the PWM frequency of the hydraulic proportional valve used.

**10** Press this button to access pages **11** of configuration of the hydraulic proportional control and scroll through the pages to set values **12/13/14/15/16/17** for each

Hydraulic control allows the setting of two separate PWM phases for both opening and closing movement.

**12a** Set the percentage of the PWM that will be applied to the proportional valve to control the retraction movement of the hydraulic cylinder in phase 1

**12b** Set the percentage of the PWM that will be applied to the proportional valve to control the forward movement of the hydraulic cylinder in phase 1

**13a** Set the phase 1 time for the hydraulic cylinder retraction movement control

**13b** Set the phase 1 time for the hydraulic cylinder forward movement control

**14a** Set the percentage of the PWM that will be applied to the proportional valve to control the retraction movement of the hydraulic cylinder in phase 2

**14b** Set the percentage of the PWM that will be applied to the proportional valve to control the forward movement of the hydraulic cylinder in phase 2

**15a** Set the PWM value update threshold for the hydraulic cylinder retraction movement control

**15b** Set the PWM value update threshold for the hydraulic cylinder forward movement control

**16a** Set the PWM value update threshold for the hydraulic cylinder retraction movement control

**16a** Set the PWM value update threshold for the hydraulic cylinder forward movement control

**17a** Set the minimum PWM value that will be applied by IBX100 to the hydraulic proportional valve to control the retraction movement of the hydraulic cylinder

**17b** Set the minimum PWM value that will be applied by IBX100 to the hydraulic proportional valve to control the forward movement of the hydraulic cylinder

Fig. 57

	Goes back to main screen		Goes back to previous menu, or scrolls the pages of a menu (previous page)		Quits without confirming the changes
	Saves the changes to current page		Scrolls the pages of a menu (next page)		Saves the changes

11.10 Home > data and settings > implement settings > Device calibration

Allows starting calibration for the devices connected to the VT.

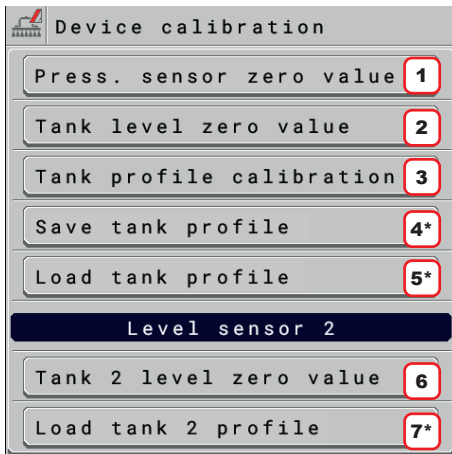

Fig. 58

- 1** allows performing the zero calibration of the pressure sensor (par. 11.10.1) if enabled in **Home > Data and settings > Implement settings > Basic settings > Tank level source > Single tank level**.
- 2** allows performing the zero calibration of the level sensor (par. 11.10.2).
- 3** allows performing the calibration of the tank profile(par. 11.10.3).
- 4\*** allows you to export a tank calibration curve previously created and stored in IBX100 internal memory (function available only if VISIO ISOBUS is present in the system or the ISOBUS File Server feature is active on VT in use) (par. 11.10.4).
- 5\*** allows a previously created tank calibration curve stored on an external USB memory to be imported into the IBX100 internal memory (function available only if VISIO ISOBUS is present in the system or the ISOBUS File Server feature is active on VT in use) (par. 11.10.5).



**to view the curve just loaded, it is necessary to restart the IBX100 as described in the paragraph 12.7.**



**The Level sensor 2 menu is ONLY present when entering in Home > Data and settings > Implement settings > Basic settings > Tank level source > Single tank level in chapter 10 on page 24.**

- 6** allows performing the zero calibration of the level sensor 2 (par. 11.10.2).
- 7\*** allows a calibration curve to be imported into the IBX100's internal memory, which will be associated with the second tank previously stored on an external USB memory (function available only if VISIO ISOBUS is present in the system or the ISOBUS FileServer feature is active on VT in use) (par. 11.10.5).



**to view the curve just loaded, it is necessary to restart the IBX100 as described in the paragraph 12.7.**



**\*The button is visible only if the VT supports the ISOBUS File server feature.**

CONTINUES



Goes back to main screen



Goes back to previous menu, or scrolls the pages of a menu (previous page)



Quits without confirming the changes



Saves the changes to current page



Scrolls the pages of a menu (next page)



Saves the changes



11.10.1 Home > Data and settings > Implement settings > Device calibration > Press. sensor zero value

In case a pressure value other than zero is displayed **despite the absence of pressure inside the circuit**, it is necessary to perform zero calibration of the sensor.

 **Before carrying out any operation disable the pump by disconnecting it from the power supply. Make sure that the pump is correctly disabled, then open the main valve and all section valves.**

- 1 Start the procedure by pressing **Start**.
- 2 Press **Confirm** to reset the pressure sensor residual signal.

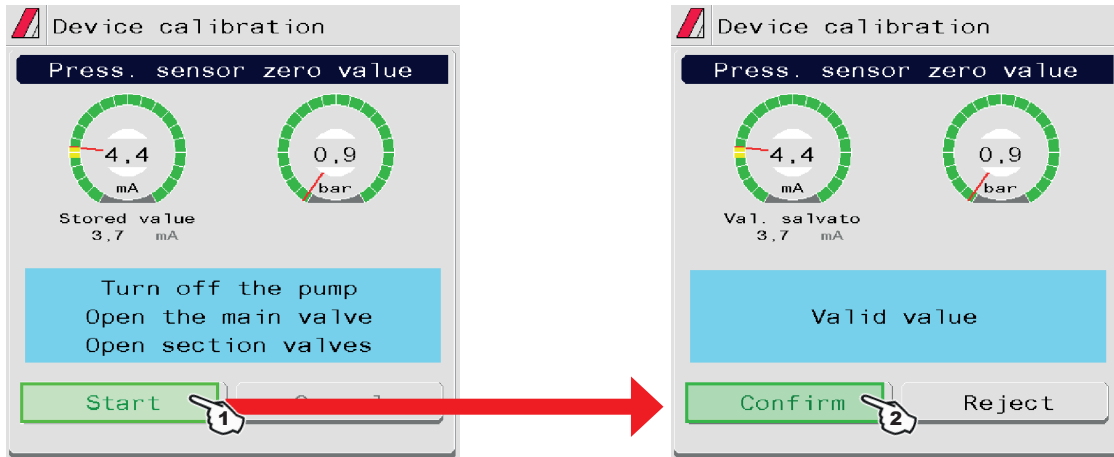

Fig. 59

**Value too low!  
Value too high!  
Unstable signal!**  
If this alarm is displayed, anomalous pressure values have been detected: check the conditions described at the beginning of the paragraph (absence of residual pressure, pump disabled). If the problem persists, check the correct sensor connection and operation.

11.10.2 Home > Data and settings > implement settings > Device calibration > Tank level zero value / Tank 2 level zero value

 **ALWAYS PERFORM THIS OPERATION WHEN A LEVEL SENSOR OF THE SYSTEM IS REPLACED.**

If the VT detects the presence of fluid inside tank, **even if empty**, set the level sensor to zero;

 **To use this menu the level sensor must be active (basic settings, chap. 10). PERFORM THE ADJUSTMENT WITH EMPTY TANK.**

- 1 Start the procedure by pressing **Start**.
- 2 Press **Confirm** to reset the level sensor residual signal.

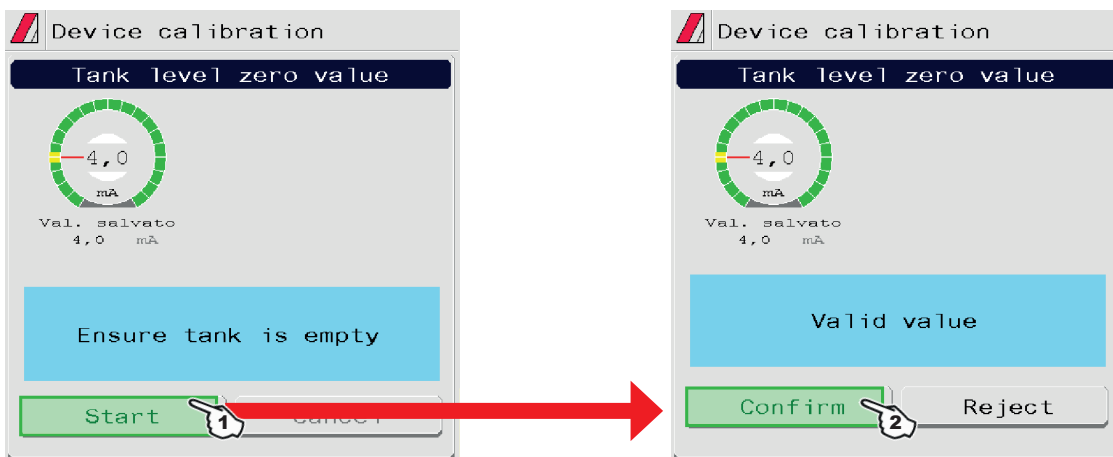

Fig. 60

**Value too low!  
Value too high!  
Unstable signal!**  
If this alarm is displayed, anomalous values have been detected: check the conditions described at the beginning of the paragraph (absence of residual fluid, level sensor enabled). If the problem persists, check the correct sensor connection and operation.

11.10.3 Home > data and settings > implement settings > Device calibration > Tank profile calibration

The calibration of the tank profile is **ONLY** possible if a flowmeter is installed on the system.



Before starting the procedure carry out the following operations:

- 1 Make sure the main control is in OFF position.
- 2 From the "Home" page, press **fn** (Functions) and disable menu **Automatic application rate**.
- 3 Fill the tank with clean water **WITHOUT ADDING CHEMICAL SUBSTANCES**. The tank must be full.  
**Visually check the reached level.**
- 4 Set the output to the maximum value by operating the regulating valve switch (nearly 7 s).  
**THE FLOWRATE MUST BE WITHIN THE FLOWMETER OPERATING RANGE.**
- 5 Start the procedure by pressing **Start**.
- 6 Start the spraying system: open, in succession, all section valves and the main control (**ON**).  
The display will show in real time the quantity of sprayed water and the calibration status.
- 7 **When the tank is empty press Confirm to end the procedure:**  
**the value read by the level sensor must be lower than 5.0 mA and at least 10 liters must have been sprayed.**

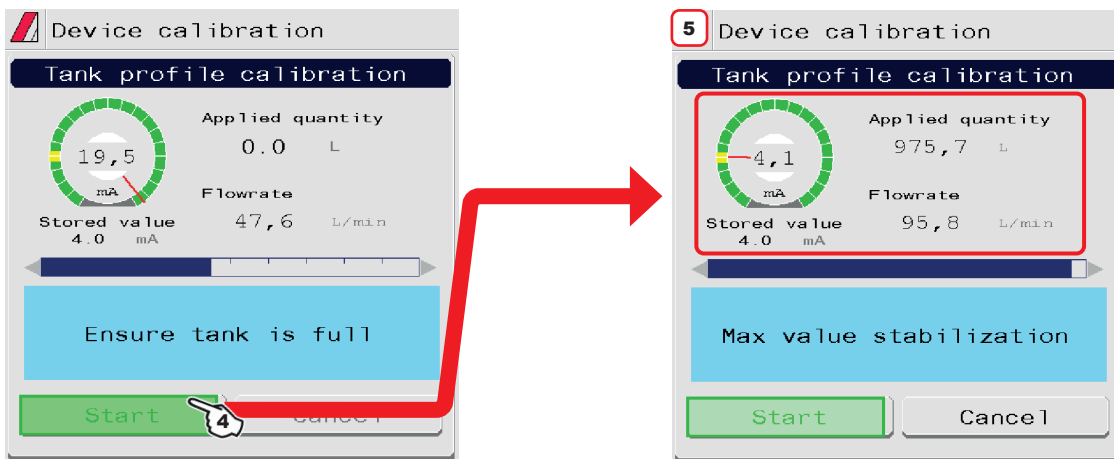

Fig. 61

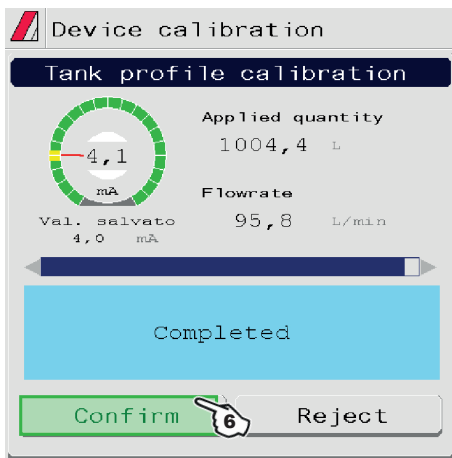









Fig. 62

In the HOME page, the icon with red background  indicates that there is NO calibration curve. When the calibration curve is present, the icon with the red background will disappear.

	Goes back to main screen		Goes back to previous menu, or scrolls the pages of a menu (previous page)		Quits without confirming the changes
	Saves the changes to current page		Scrolls the pages of a menu (next page)		Saves the changes

11.10.4 Home > data and settings > implement settings > Device calibration > Save tank profile

Saves the tank profile calibration file in the IBX100 internal memory.

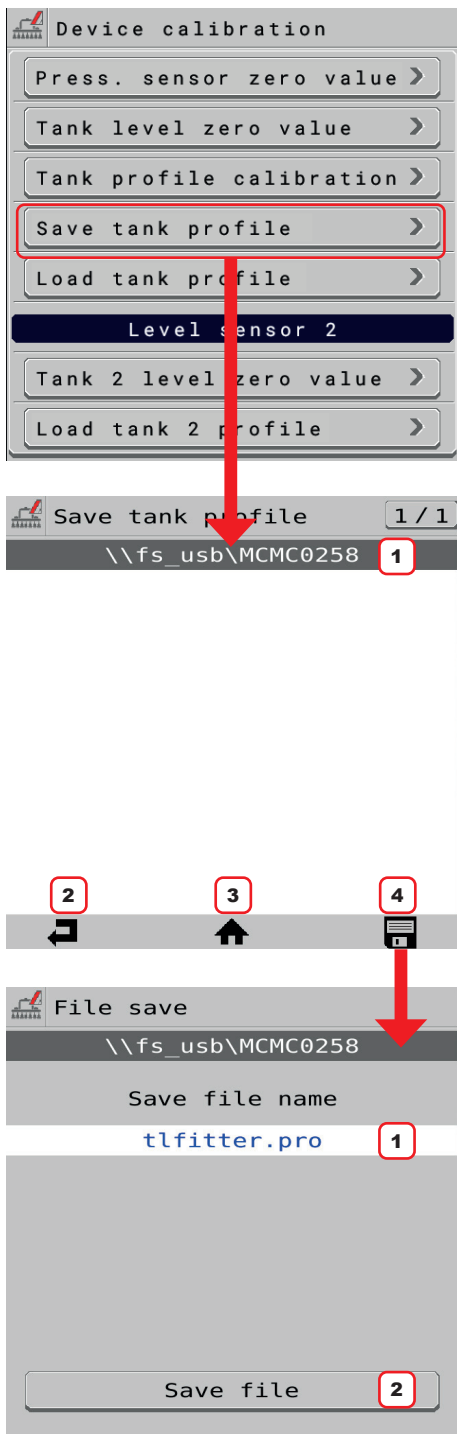

Fig. 63

Press **Save tank profile** to enter the File server management menu from which you can select the folder to which to export the tank profile file (e.g. to a USB pendrive).



The button is visible only if the VT supports the ISOBUS File server feature.

**1** Current folder path.

*MCMC0258 is the initial folder automatically created by the client file server and refers to ARAG because 0258 is the code that identifies ARAG as the ISOBUS component manufacturer.*

**2** BACK. Goes back to the previous folder.

**3** HOME. Returns directly to the home folder (MCMC0258) - This function may not be available in all Virtual Terminals.

**4** SAVE. Selects the current path and accesses the file saving page.

*An existing file can be overwritten by selecting it from those listed.*

*A blue rectangle will indicate the selected file*

**1** Type the name you want to assign to the tank profile file to save.

**DO NOT CHANGE THE FILE EXTENSION. FILE EXTENSION MUST ALWAYS BE .pro**

*If the name assigned to the backup file to be saved is the same as that of a file already present in the selected folder, **the latter will be overwritten and permanently lost.***

**2 Save file:** Saves the file to the external memory connected to the VT.



Goes back to main screen



Goes back to previous menu, or scrolls the pages of a menu (previous page)



Quits without confirming the changes



Saves the changes to current page



Scrolls the pages of a menu (next page)



Saves the changes

11.10.5 Home > Data and settings > Implement settings > Device calibration > Load tank profile / Load tank 2 profile

Allows importing a tank profile calibration file present in an external memory connected to the Virtual Terminal.





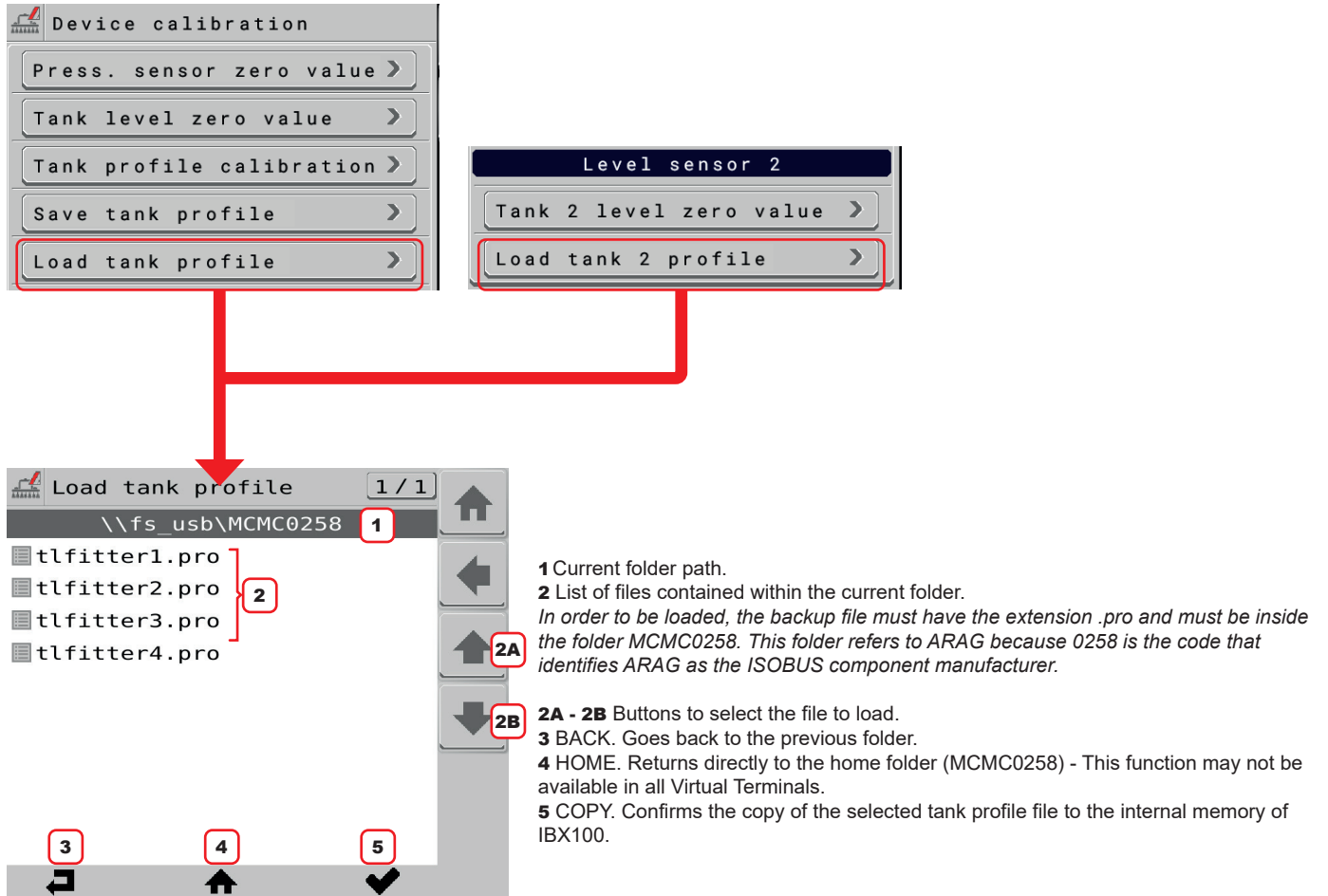

Press **Load tank profile / Load tank 2 profile** to enter the File server management menu from which you can select the folder from which to import the Tank profile file.

 **Buttons Load tank profile and Load tank 2 profile are visible only if the VT supports the ISOBUS File server feature. Calibration curve for Tank 2 can only and exclusively be loaded by means of Visio Isobus (from sw 1.2.x version).**



**1** Current folder path.  
**2** List of files contained within the current folder.  
*In order to be loaded, the backup file must have the extension .pro and must be inside the folder MCMC0258. This folder refers to ARAG because 0258 is the code that identifies ARAG as the ISOBUS component manufacturer.*  
**2A - 2B** Buttons to select the file to load.  
**3** BACK. Goes back to the previous folder.  
**4** HOME. Returns directly to the home folder (MCMC0258) - This function may not be available in all Virtual Terminals.  
**5** COPY. Confirms the copy of the selected tank profile file to the internal memory of IBX100.

Fig. 64

	Goes back to main screen		Goes back to previous menu, or scrolls the pages of a menu (previous page)		Quits without confirming the changes
	Saves the changes to current page		Scrolls the pages of a menu (next page)		Saves the changes

11.11 Home > Data and settings > implement settings > Implement geometry

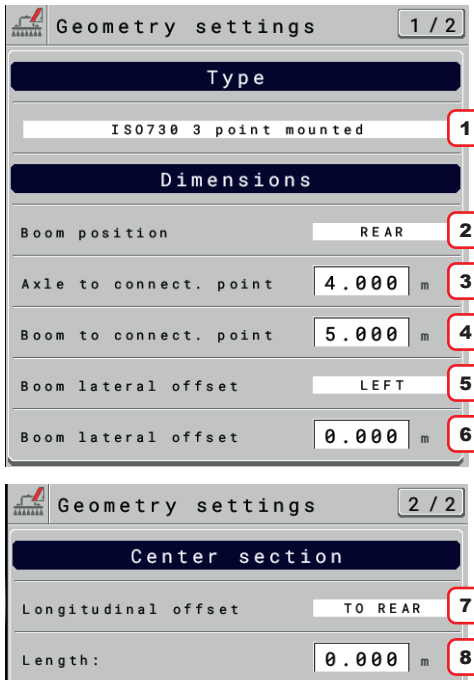

Check Virtual Terminal settings: if a specific menu is available (varying based on your VT) to program machine geometry, it has the priority over the ECU menu.

1 Select the type of implement connection.

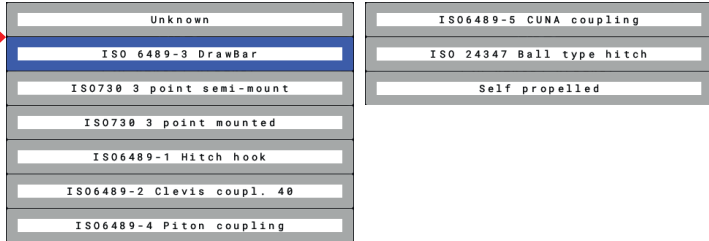

2 Indicate the position of the implement relative to the tractor:  
**REAR:** the implement is connected to the rear of the tractor.  
**FRONT:** the implement is connected to the front of the tractor.



This option is available only if a mounted implement has been selected in the Type item.

3 - 4 Enter the selected implement dimensions.

5 Available options **NO / LEFT / RIGHT:**

setting **LEFT / RIGHT** enables item 6 **Boom lateral offset**, where the actual value (in meters "m" / feet "ft") of the boom lateral offset can be entered.

7 Allows you to enter the distance between the point of application of the nozzles on the center section and those on the two half-booms, item 8.

8 Setting **TO REAR / TO FRONT** in item 7 enables item **Length**, where the value (in meters "m" / feet "ft") of the actual longitudinal offset with respect to the wing fitting point can be entered.

Fig. 65

Axle to connect. point	Boom to connect. point	Boom lateral offset
------------------------	------------------------	---------------------

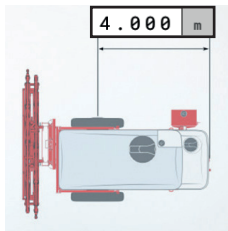

Fig. 66

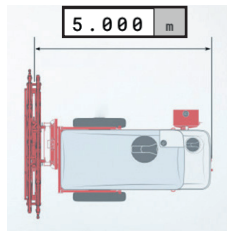

Fig. 67

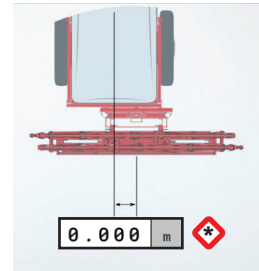

Fig. 68

\* Boom lateral offset: LEFT

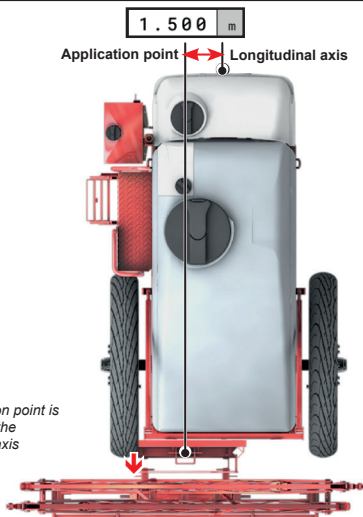

Fig. 69

\* Boom lateral offset: RIGHT

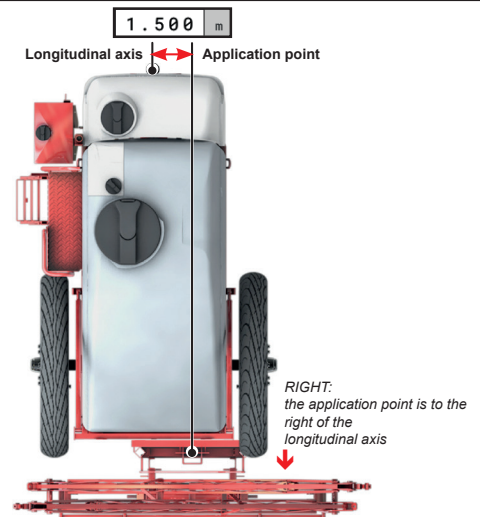

Fig. 70

Longitudinal offset

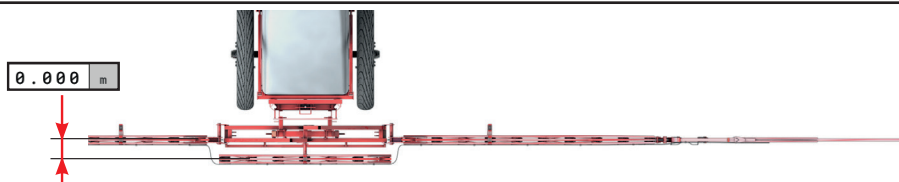

Fig. 71

11.12 Home > data and settings > implement settings > System configurations

Set the device system options.

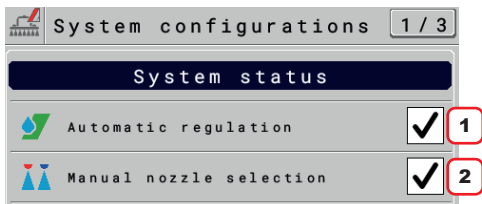

Fig. 72

**System**

**1** The setup of this item makes **visible / invisible** the **Application rate regulation** function of the **Automatic functions** menu (par. 15.3.1).

**2** The setup of this item enables nozzle manual selection.

The item is present only if

- in **Basic settings** the **Sprayer technology > Valves, Boom settings > Dual** options are active and in active **Preset** two nozzles are selected.

- in **Basic settings** the **Sprayer technology > Seletron** options are active, **Spraying point type > 2** or **4**.



**Manual nozzle selection**



**Automatic nozzle selection**

Nozzle selection modes are described in par. 15.3.2 Home > Automatic functions > Nozzles selection.

**SPRAYING REMOTE CONTROL**

**3** Select the type of spraying remote control connected to the VT.

**None (DEFAULT)**

**Spraying disabled (ECU)**

Allows managing the external general control connected to the IBX100.

- MAIN CONTROL ON: Open contact
- MAIN CONTROL OFF: Closed contact

**Spraying enabled (ECU)**

Allows managing the external general control connected to the IBX100.

- MAIN CONTROL ON: Closed contact
- MAIN CONTROL OFF: Open contact

**Spraying enabled (Tecu)**

allows managing the external general control through a Tecu device (ref. to relevant instruction manual).

**REMOTE DEVICES**

**4** The VT can access the functions of the connected device (ref. to relevant instruction manual).

**None (DEFAULT)**

**Visio-Isobus**

The VT displays in real time the tank filling (par. 15.4) carried out with the connected Visio ISOBUS.

Vision functions available:

- Filling check with flowmeter.
- Filling check with level sensor.

It allows the transfer of a system backup and of the tank profile between IBX100 and a USB pendrive or vice versa.

**Syncro-Isobus**

From the dedicated page, the user can remotely manage the functions of Syncro (par. 17.5).



Fig. 73

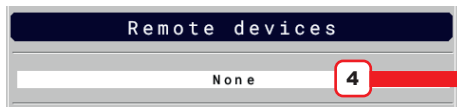

Fig. 74

CONTINUES



Goes back to main screen



Goes back to previous menu, or scrolls the pages of a menu (previous page)



Quits without confirming the changes



Saves the changes to current page



Scrolls the pages of a menu (next page)



Saves the changes

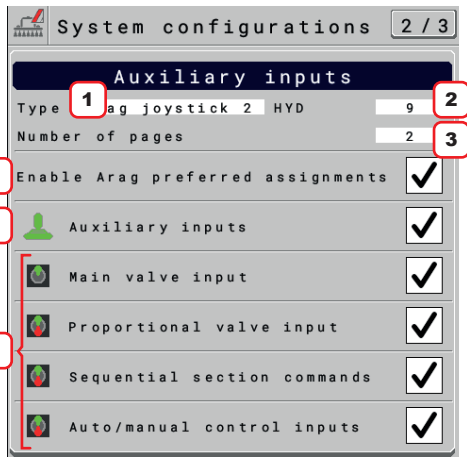
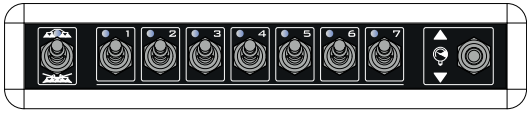





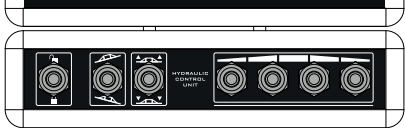

Fig. 75

**AUXILIARY INPUTS**

**1 Type:** Select the type of auxiliary control (Auxiliary Input) connected to the system.

Direct	
Sequential	
ARAG Joystick1	 Select the <b>ARAG Joystick1</b> option if you intend to use the Explorer 1 joystick.
ARAG Joystick2	 Select the <b>ARAG Joystick2</b> option if you intend to use the Explorer 2 joystick in the 27-button version.
Tractor joystick	Third-party ISOBUS auxiliary input.
Hydraulic only	

**2 HYD (hydraulic):** Select the number of hydraulic sections connected to the system.  
**If the hydraulic valve management is handled by IBX100 Hydraulic Isobus, select zero as HYD value.**

0	No hydraulic control is present.
7	
9	

**3 Number of section switches:**  
**Item available for Direct type control panel ONLY.**  
 Indicate the number of section switches. Available options: 0 / 4 / 5 / 6 / 7 / 9 / 11 / 13

**3 Using center section switch:**  
**Item available for sequential type control panel ONLY.**

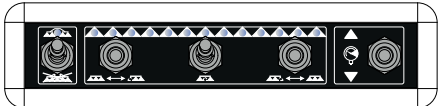

If the sequential panel has the control of the central section (total number of sequential switches 2 + 1 direct) choose **YES**.  
 If it does not have it (total number of sequential switches 2) choose **NO**.

**3 Number of pages**  
**Item available ONLY for Arag joystick 2 type.**  
 Select the number of pages you wish to configure.

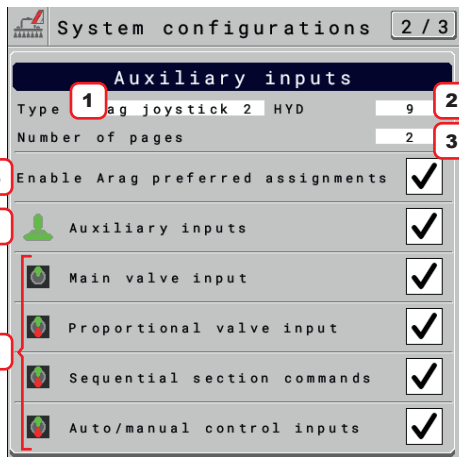

Fig. 76

**AUXILIARY INPUTS**

**4** Enable / Disable the prompt for the system to load the ARAG default functions (NOT available for the **Tractor Joystick** auxiliary control).

Disabled option : allows you to independently assign functions for the connected Auxiliary Input.

On the right side appears the button that allows to delete any custom assignments. Once deleted, they need to be reassigned.

**5** Enable / disable the auxiliary input selected in point 1.

**6** Enable / Disable the displayed inputs, linked to the selected Auxiliary Input:

**Main valve input:**

by enabling this item, the IBX100 Sprayer control unit shows the function that can be associated with the Main valve

**Proportional valve input:**

by enabling this item, the IBX100 Sprayer control unit shows the function that can be associated with the Proportional Valve

**Sequential section commands:**

by enabling this item, the IBX100 Sprayer control unit shows the function that can be associated with the sequential commands

**Auto/Manual control inputs:**

by enabling this item, the IBX100 Sprayer control unit shows the function that can be associated with the Auto-Man control inputs

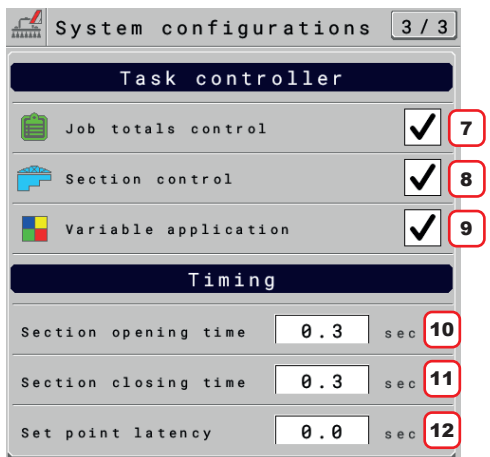

Fig. 77

**TASK CONTROLLER**

The VT can make some functions through the TC, ONLY IF THEY ARE enabled in this screen:

**7** Enable / disable the job total counter control.

**8** Enable / Disable the automatic section control.

**9** Enable / disable the use of prescription maps for treatments with variable application.

**TIMING**

The correct management of valve timing, set on implement OP (IBX100), may vary based on the connected VT.

**10** Indicate the time between the moment when the command is sent to the valves and the actual moment in which product output starts.

**11** Indicate the time between the moment when the command is sent to the valves and the actual moment in which product output stops.

**12** Adjustment parameter for variable applications (with the use of prescription maps): this datum is used to indicate the advance time of application rate adjustment when the machine approaches the area changeover of the prescription map.

	Goes back to main screen		Goes back to previous menu, or scrolls the pages of a menu (previous page)		Quits without confirming the changes
	Saves the changes to current page		Scrolls the pages of a menu (next page)		Saves the changes



11.13 Home > data and settings > implement settings > Rate controller

Allows configuring the activation of the alarms relating to application rate display and regulation:

1 / 2

**Rate regulation cutoff:**

- **Regulation cutoff:** Indicate the percentage of tolerance relative to the application rate target beyond which the control valve no longer regulates because it considers it to have been reached.

**Rate display cutoff:**

- **Display cutoff:** Indicate the rate display tolerance percentage beyond which the alarm is triggered and the system displays the actual rate value. Within the set percentage, the system continues displaying the preset rate even if different from the actual one.

2 / 2

**Regulation settings:**

- **Type:** displays the type of actuator used by the system to adjust the application rate selected in the basic implement settings.
- **Aggressiveness:** Checks the power applied to the selected actuator to regulate the system flow.

It reduces aggressiveness. /  It increases aggressiveness.

The ideal calibration is achieved when the application rate remains constant even with minor variations in driving speed.

- **Pump control PWM settings:** item available only if the actuator type for preselected application rate regulation is **Pump**.

- **Minimum PWM:** set the desired minimum value for hydraulic proportional valve control. This setting will determine the minimum rotation speed of the pump.
- **Starting PWM:** set the desired value that IBX100 will apply to the hydraulic proportional valve when the pump state changes from OFF to ON. Once the pump is started, the system will automatically set the PWM value, and thus the proportional valve state, to the situation that meets the working conditions.
- **Not Spraying PWM:** set the desired value for hydraulic proportional valve control when all sections are closed. This setting will determine the rotation speed of the pump when the treatment is closed.
- **Maximum PWM:** set the desired maximum value for hydraulic proportional valve control. This setting will determine the maximum rotation speed of the pump.

11.14 Home > data and settings > implement settings > "Fence"

Allows setting the characteristic data of the "Fence" nozzle.

Fig. 78

**1 - 2** Set the reference flowrate and pressure for the "Fence" nozzle. These data allow the correct adjustment of the application rate when "Fence" nozzles are enabled.

	Goes back to main screen		Goes back to previous menu, or scrolls the pages of a menu (previous page)		Quits without confirming the changes
	Saves the changes to current page		Scrolls the pages of a menu (next page)		Saves the changes

11.15 Home > Data and settings > Implement settings > Flowmeter presets

Allows setting flowmeter data.

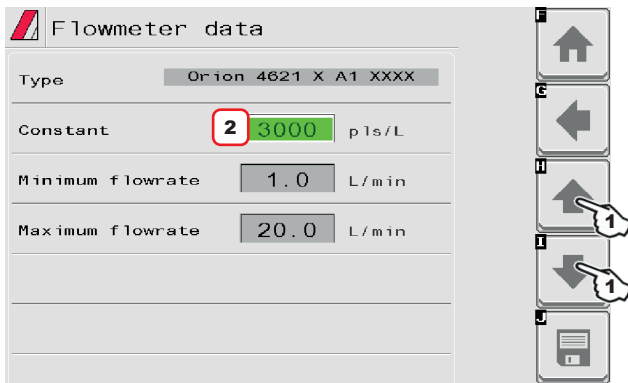

- 1 Select the flowmeter to be set with keys.
- 2 Set the **Constant**.



The items Minimum flowrate and Maximum flowrate can be modified only when the option Other is enabled.

Fig. 79

List of available flowmeters and preset data:

**ORION FLOWMETERS**

Type	Constant		Minimum flowrate		Maximum flowrate	
	pls/l	pls/gal	l/min	GPM	l/min	GPM
4621 x A0 xxxx	6000	22710	0.5	0.10	10	2.6
4621 x A1 xxxx	3000	11355	1	0.30	20	5.3
4621 x A2 xxxx	1200	4542	2.5	0.70	50	13.2
4621 x A3 xxxx	600	2271	5	1.30	100	26.4
4621 x A4 xxxx	300	1135	10	2.60	200	52.8
4621 x A5 xxxx	150	568	20	5.30	400	105.7
4621 x A6 xxxx	100	378	30	7.90	600	158.5

**WOLF FLOWMETERS**

Type	Constant		Minimum flowrate		Maximum flowrate	
	pls/l	pls/gal	l/min	GPM	l/min	GPM
462 x 2 xxx	1025	3880	2.5	0.7	50	13.2
462 x 3 xxx	625	2366	5.0	1.3	100	26.4
462 x 4 xxx	250	946	10.0	2.6	200	52.8
462 x 5 xxx	132	500	20.0	5.3	400	105.7
462 x 7 xxx	60	227	40.0	10.6	800	211.3

**ORION WR FLOWMETERS**

Type	Constant		Minimum flowrate		Maximum flowrate	
	pls/l	pls/gal	l/min	GPM	l/min	GPM
Other	625	2366	10	2.60	200	52.8

Type	Constant		Minimum flowrate		Maximum flowrate	
	pls/l	pls/gal	l/min	GPM	l/min	GPM
462W100	6000	22710	0.3	0.08	100	26.4
462W200	3000	11355	0.5	0.13	200	52.8



Goes back to main screen



Goes back to previous menu, or scrolls the pages of a menu (previous page)



Quits without confirming the changes



Saves the changes to current page



Scrolls the pages of a menu (next page)



Saves the changes

**12 DATA AND SETTINGS**

**12.1 Data and settings > Manage presets**

From this menu:

- Set 8 different spraying configurations: PRESET SETTING, Fig. 80.
- Set 2 different nozzle configurations depending on the type of valves installed:
  - VALVES WITH GEARMOTOR (SINGLE BOOM) OR SINGLE SELETRON, Fig. 82.
  - VALVES WITH DUAL BOOM GEARMOTOR OR WITH TWIN OR FOURFOLD SELETRON VALVES page 44.
- Activate one configuration among the preset ones: ATTIVAZIONE DI UN PRESET on page 45.
- Consult job data of the spraying selected: Totalizzatori - Medie on page 45.

**PRESET SETTING**

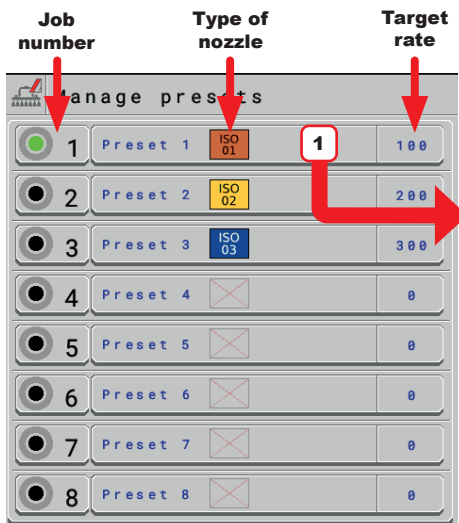

Fig. 80

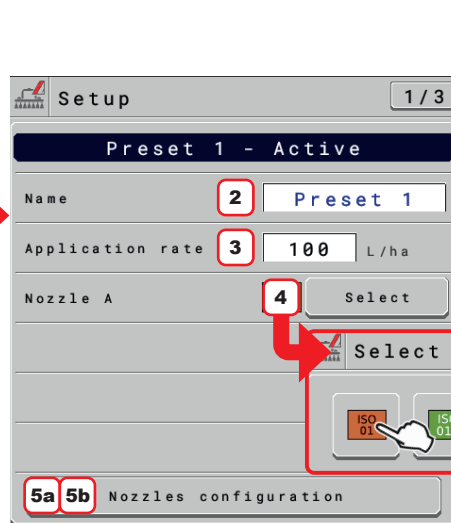

Fig. 81

Features to set for each **Preset**:

- 1 Select the **Preset** to be set.
- 2 Type in the name.
- 3 Enter the application rate value (L/Ha).
- 4 Select the type of nozzle among the suggested ones:
  - 12 types of ISO nozzles and 6 customized nozzles.

**Nozzle type:** thanks to multiple nozzle holders (twin or fourfold Seletron units), it changes the number of nozzles to be programmed (2 or 4).

**5a Data and settings > Manage presets > Setup > Nozzles configuration: VALVES WITH GEARMOTOR (SINGLE BOOM) OR SINGLE SELETRON**

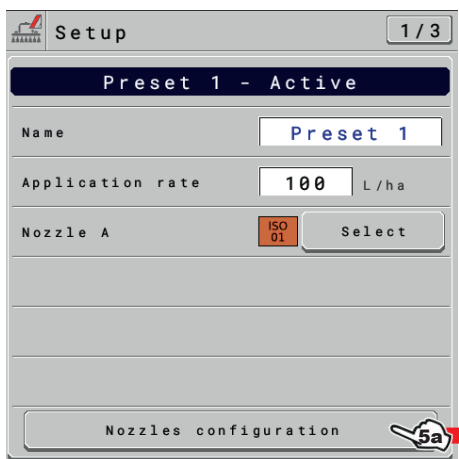

Fig. 82

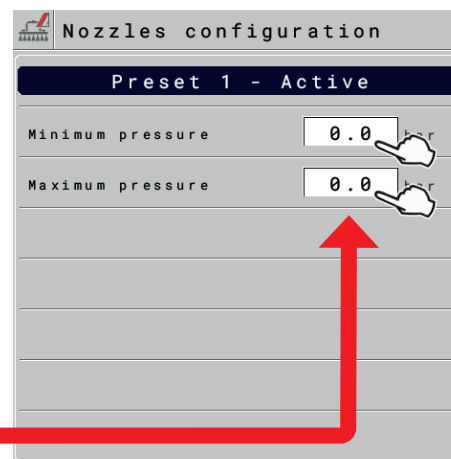

Fig. 83

This menu has two purposes:

- Setting the function range of the control valve  
If you set pressure values, the control valve operates **ONLY** in that pressure range. Below the minimum value and above the maximum value it no longer regulates. The corresponding symbols are displayed on the job page (figure a page 66):  
Minimum pressure not reached   
Maximum pressure exceeded
- This function can be activated even if the pressure sensor is not set.
- Generating an alarm  
Set the pressure limits for the selected nozzle and enable the appropriate function of the **Alarms** menu (ref. 3 Fig. 95 on page 47) if you want the system to generate an alarm when the nozzle is outside the set limits.

CONTINUES **5b**

	Goes back to main screen		Goes back to previous menu, or scrolls the pages of a menu (previous page)		Quits without confirming the changes
	Saves the changes to current page		Scrolls the pages of a menu (next page)		Saves the changes

**5b** Data and settings > Manage presets > Setup > Nozzles configuration:  
**VALVES WITH DUAL OR SINGLE BOOM GERMOTOR WITH TWIN OR FOURFOLD SELETRON VALVES**



Fig. 84

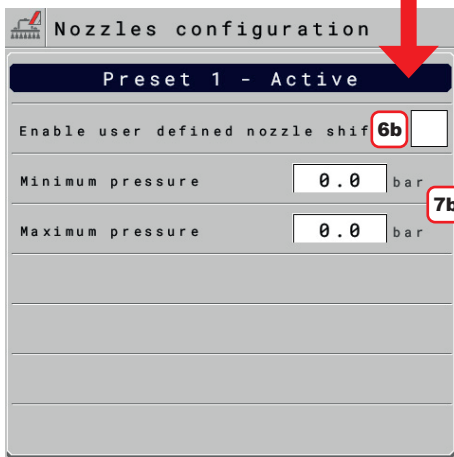

Fig. 85



**6b** Disabling the menu:

Menu disabled for Preset 1

**7b** Set the minimum and maximum control PRESSURE of the system.

This menu has two purposes:

- Setting the function range of the control valve  
 If you set pressure values, the control valve operates ONLY in that pressure range. Below the minimum value and above the maximum value it no longer regulates. The corresponding symbols are displayed on the job page (figure a page 66):

Minimum pressure not reached   
 Maximum pressure exceeded 

This function can be activated even if the pressure sensor is not set.

- Generating an alarm

Set the pressure limits for the selected nozzle and enable the appropriate function of the **Alarms** menu (ref. **3-4** Fig. 95 on page 47) if you want the system to generate an alarm when the nozzle is outside the set limits.

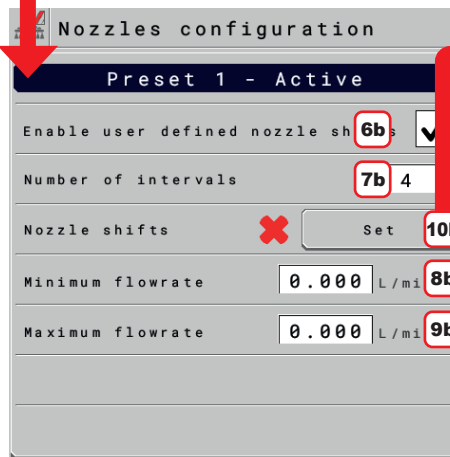

Fig. 86

**6b** Make the menu active for configuration:

Menu enabled for Preset 1

**7b** Indicate the number of customized ranges.

**8b** Set the FLOWRATE of the regulating valve operating range for your system.  
 You must enter the flowrate value of the nozzle you are using (par. 11.5 Home > data and settings > implement settings > Nozzle data).  
 In order to obtain a more reactive system, it is possible to enter a flowrate value slightly lower than the nominal one of the nozzle.  
 Below the minimum flowrate entered, the system will not regulate.

**9b** Set the maximum FLOWRATE of the regulating valve operating range for your system.  
 You must enter the sum of the minimum flowrate (par. 11.5 Home > data and settings > implement settings > Nozzle data) and the flowrates of the selected nozzles (Fig. 87) (ref. **3** Fig. 50 on page 27).  
 Above the maximum flowrate the system does not regulate.  
 The reference value can be found in the ISO standard nozzle tables and is relative to a pressure of 3 bar.

**10b** Select the **Nozzle shifts** menu to program nozzle combinations.

**Nozzle shifts**

Optimizes nozzle automatic selection: it allows setting up one nozzle combination, using ONLY SOME in relation to a flowrate range.

Each range has a specific nozzle combination and an exchange flowrate that, once exceeded, will make the computer use the combination of the next range:

**11b** Select the nozzles to be used among the suggested ones for each range: should you disable one or more nozzles, select them using arrow keys (one at a time)

**12b** Program the flowrate limit of the corresponding range.  
 Set all ranges.

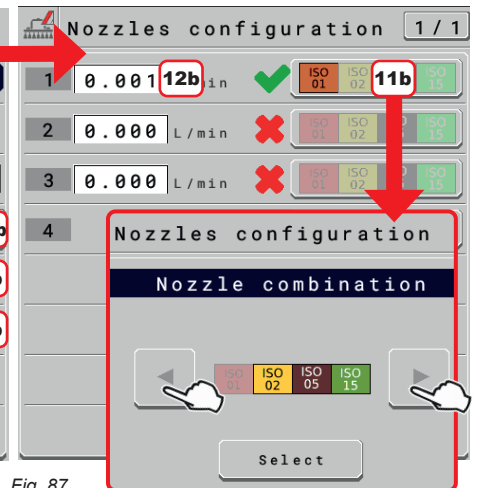

Fig. 87

**PRESET ACTIVATION**

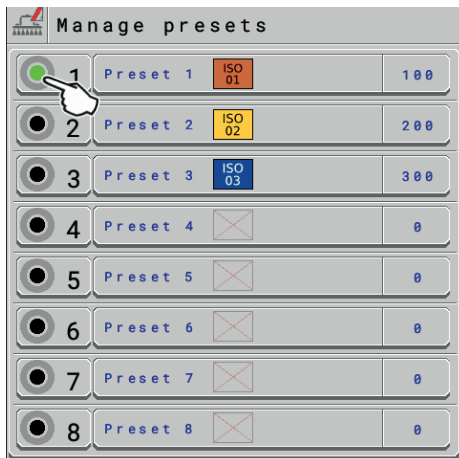

Fig. 88

**CONSULTATION OF JOB DATA OF THE SELECTED PRESET**

- Select the **Preset**.
  - Use key **1** to scroll pages and key **2** to delete the job data;
- WARNING: total counters and average values are simultaneously deleted.**

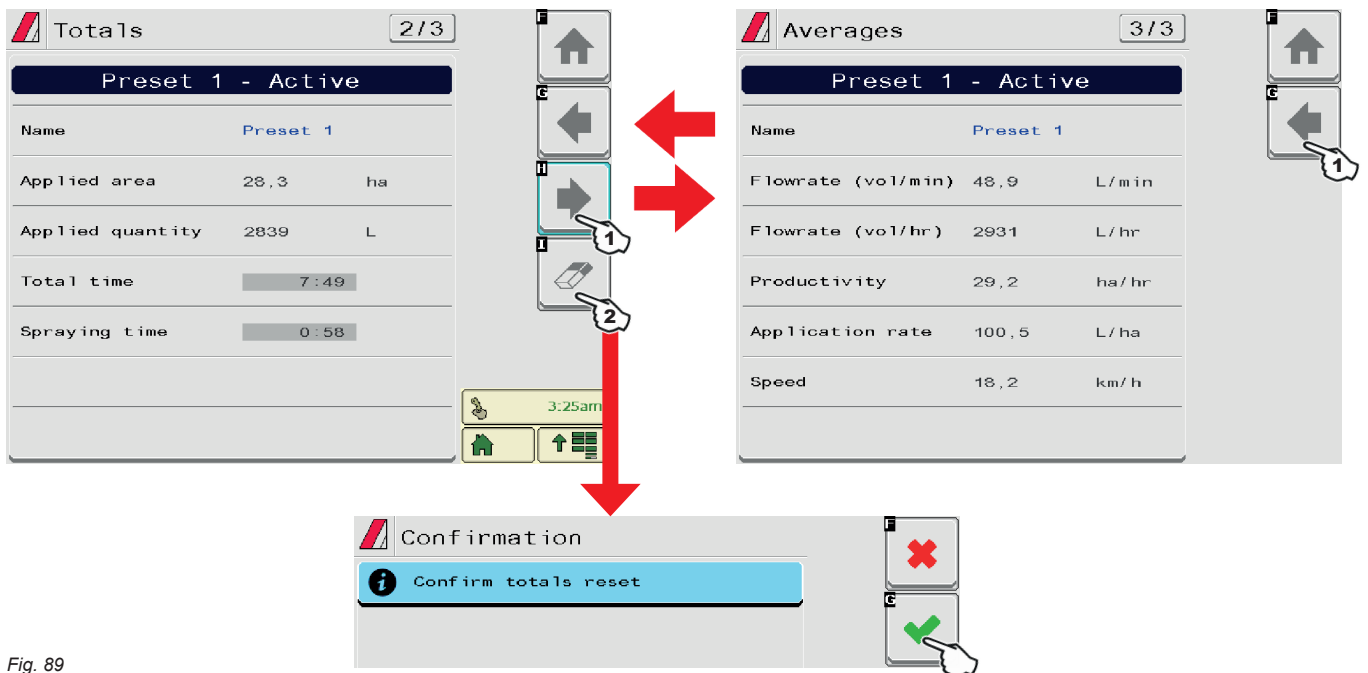

Fig. 89

	Goes back to main screen		Goes back to previous menu, or scrolls the pages of a menu (previous page)		Quits without confirming the changes
	Saves the changes to current page		Scrolls the pages of a menu (next page)		Saves the changes

12.2 Data and settings > Working parameters

Set the farming machine job limits.

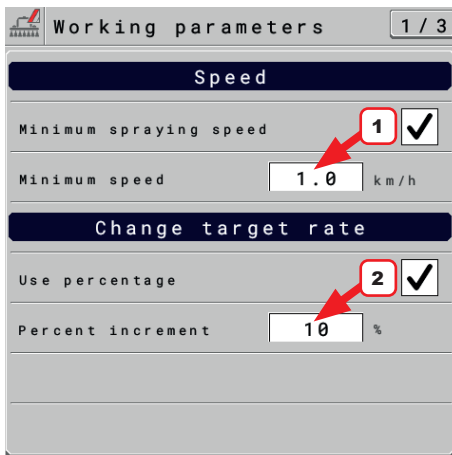

Fig. 90

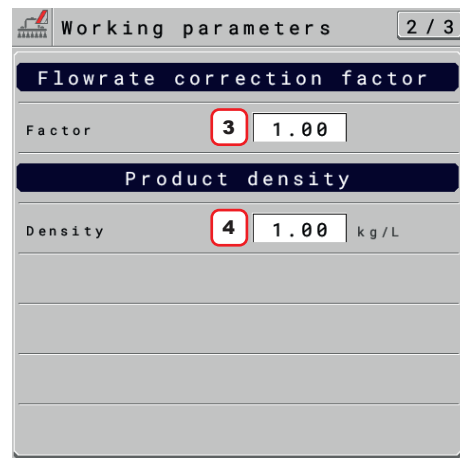

Fig. 91

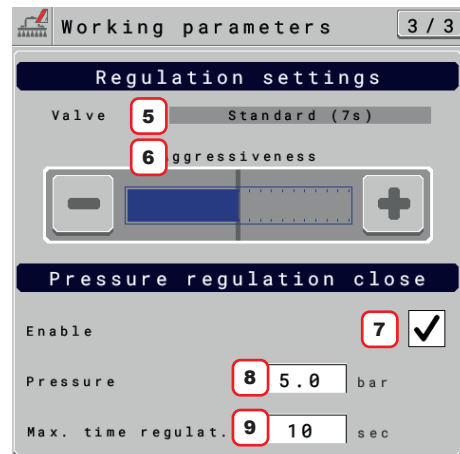

Fig. 92

**SPEED**

**1** To configure the items on this menu, you must enable the speed limit. Set the minimum spraying speed: IBX100 Sprayer closes the main valve when the tractor speed is lower than the set value.

**CHANGE TARGET RATE**

**2** Set the target rate change mode and increment value.

**ENABLED:** percentage increment

**DISABLED:** rate increment in l/ha

The target rate change is carried out with the job function described in par. 15.1.

**FLOWRATE CORRECTION FACTOR**

**3** When using a paddle flowmeter and the sprayed fluid has a different viscosity than that of water, the VT could display wrong measurements; to correct them change the flowrate correction factor:

- if at the end of the spraying the tank still contains fluid, reduce the factor;
- if the fluid finishes before the job has ended, increase the factor.

**Flowmeters of the ORION series (code 462xAxxxx) are not affected by the viscosity difference of the fluids: set the factor to 1.00.**

**PRODUCT DENSITY**

**4** If the sprayed fluid is lighter than water, the device may indicate wrong measurements; to correct this measurement, edit the sprayed liquid weight, referred to 1 liter of product. **A tank level sensor must be installed.**

**REGULATION SETTINGS**

**5** Displays the type of selected regulation valve.

**6** Checks the power applied by the selected valve to regulate the system flow.  
- It reduces aggressiveness.  
+ It increases aggressiveness.

The ideal calibration is achieved when the application rate remains constant even with minor variations in driving speed.

**PRESSURE REGULATION CLOSE**

**7** Function of the regulating valve during closing







**ENABLED:** The system tries to reach the set pressure acting on the regulating valve (AUTO mode enabled with main valve closed) ONLY for the time entered (**9**), after which the system does not intervene on the valve anymore.

**DISABLED**

**8** Set the pressure value to be reached when the sections are closed.

**9** Maximum time needed by the regulating valve to bring the boom to the set pressure.

This function can be activated only if the pressure sensor is set in the basic settings and installed on the implement.

	Goes back to main screen		Goes back to previous menu, or scrolls the pages of a menu (previous page)		Quits without confirming the changes
	Saves the changes to current page		Scrolls the pages of a menu (next page)		Saves the changes

12.3 Data and settings > Info and alarms

From this menu you can enable alarm visual and acoustic notifications when the related event occurs.

Alarm enabled /  Alarm disabled.

For the procedure to be followed when an alarm occurs, please refer to par. 18.3 Error messages.

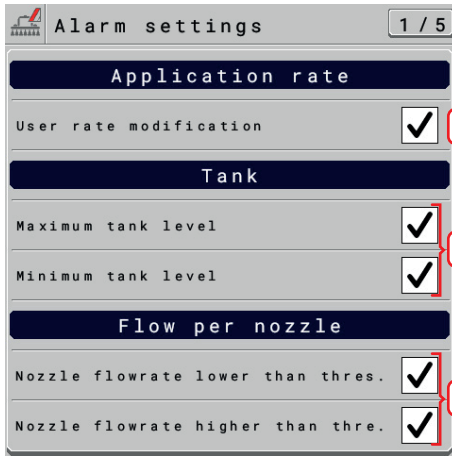

Fig. 93

**APPLICATION RATE ALARM**

1 Alarm active when user changes the application rate during treatment (par. 15.1).

**TANK ALARMS**

2 One of the two alarms is enabled if the (minimum or maximum) tank level exceeds the set values (par. 11.8).

**NOZZLE FLOWRATE**

3 Outside the range set in the menus **Minimum flowrate / Maximum flowrate** (Fig. 86 on page 44), the VT triggers an alarm.

The items are only present if the following options are active in **Basic settings**:

- **Sprayer technology > Seletron together with Spraying point type > 2 / 4**
- **Sprayer technology > Valves together with Boom settings > Dual (dual boom).**

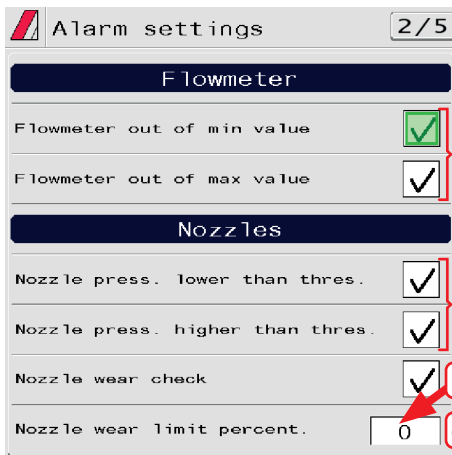

Fig. 94

**FLOWMETER ALARMS**

1 Outside the range set in the **Minimum flowrate / Maximum flowrate** menus (par. 11.2 Home > data and settings > implement settings > Flowmeters), the VT triggers an alarm.

It is essential that in the **Implement settings > Basic settings > Flowrate reference sensor** menu, the item **Flowmeter** is selected.

**NOZZLE ALARMS**

2 Outside the range set in the **Minimum pressure / Maximum pressure** menus related to each **single nozzle** (par. 11.5 Home > data and settings > implement settings > Nozzle data), the VT triggers an alarm.

3\* Enable/disable nozzle wear check and set the tolerance threshold in point 6\*.

4\* Set the threshold: the VT compares the effective flowrate read by the flowmeter and the one calculated by the pressure sensor.

When the difference between the two flowrate values exceeds the set percentage, the alarm is triggered.

\* the items are available ONLY if the pressure sensor is present.

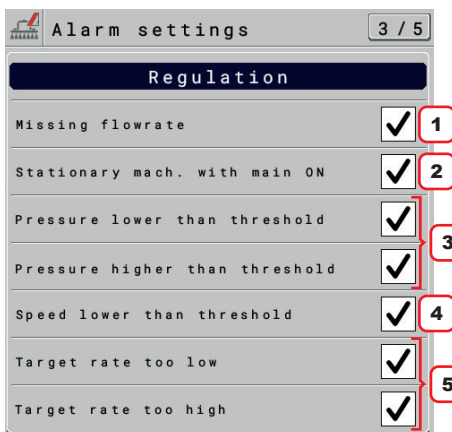

Fig. 95

**ADJUSTMENT ALARMS**

1 Alarm is enabled with main control ON but flowrate at zero.

2 Alarm is enabled with main control ON with machine stopped.

3 Alarms are activated if the system does not reach the set pressure limits. (Fig. 83 on page 43 and Fig. 85 on page 44).

4 Alarms are enabled if the speed does not reach the set limit values (par. 12.2).

5 Alarm is activated if the output (l/ha or GPM) is different from the set application rate (par. 12.1).

CONTINUES

	Goes back to main screen		Goes back to previous menu, or scrolls the pages of a menu (previous page)		Quits without confirming the changes
	Saves the changes to current page		Scrolls the pages of a menu (next page)		Saves the changes

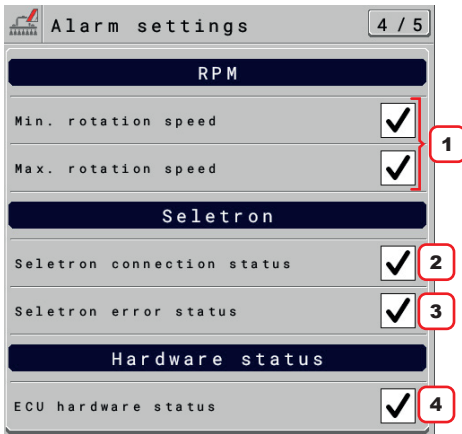

Fig. 96

**RPM ALARMS**

**1** Outside the range set in the menus  
**Minimum rotation speed / Maximum rotation speed**  
 (par. 11.7 Home > data and settings > implement settings > Rev counter), the VT triggers an alarm.

**SELETRON ALARMS**

**Alarms relating to Seletron valves (Basic settings, chap. 10):**  
**2** Alarm is activated when (one or more) spraying points do not respond.  
**3** Alarm is activated when the input voltage on one or more spraying points is too low.

**HARDWARE ALARMS**

**4** Enable / disable ECU hardware status alarm.

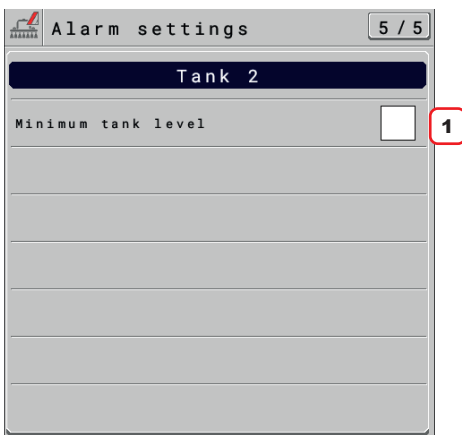

Fig. 97

**TANK 2 ALARM**

**1** The alarm is enabled if the minimum tank 2 level exceeds the set values (par. 11.8).



Goes back to main screen



Goes back to previous menu, or scrolls the pages of a menu (previous page)



Quits without confirming the changes



Saves the changes to current page



Scrolls the pages of a menu (next page)



Saves the changes



12.4 Data and settings > implement settings

Consult chap. 11 Implement settings > Advanced Setup.

12.5 Data and settings > Job data

Allows consulting the spraying total data relating to applied area and job time

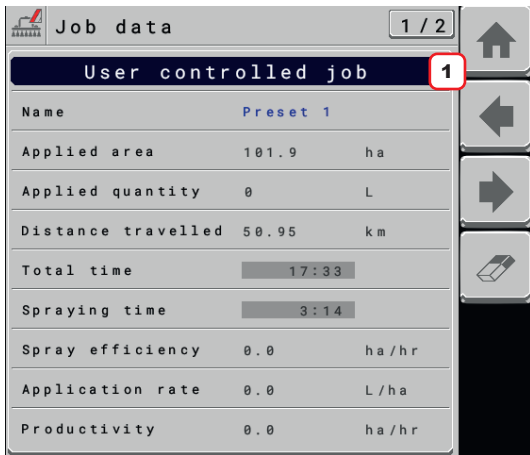

Fig. 98

**1 TASK CONTROLLER JOB**

Task controller job: (fig. 1) It allows you to look up the total treatment data by having the task controller basic working **Home > Data and settings > Implement settings > System configurations > Job totals control > Working**. (TC-BAS working = management of job data collection start controlled by the ISOBUS Virtual Terminal)

or

**1 USER CONTROLLED JOB**

User controlled job: (fig. 2) It allows you to look up the total treatment data by having the task controller basic NOT working **Home > Data and settings > Implement settings > System configurations > Job totals control > NOT working** or if the VT does not have the TC basic. (TC-BAS not working = management of job data collection start controlled by IBX100 ISOBUS SPRAYER - use the eraser to reset the data)

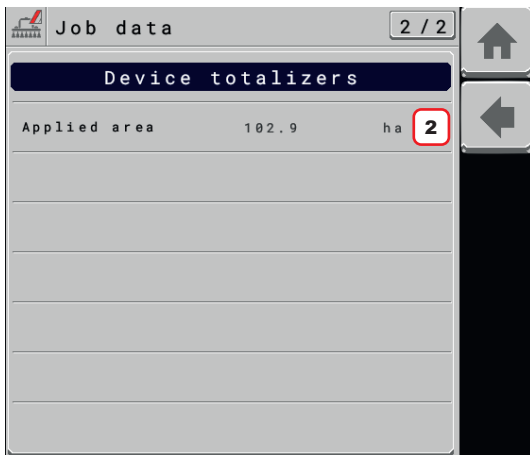

Fig. 99

**DEVICE TOTALIZERS**

**2** total counter of hectares tilled by the machine since it started to be used.

A factory reset must be performed to reset it to zero: **Data and settings > System > System settings > Settings manager > Reset to Arag factory defaults** on page 76)



Goes back to main screen



Goes back to previous menu, or scrolls the pages of a menu (previous page)



Quits without confirming the changes



Saves the changes to current page



Scrolls the pages of a menu (next page)



Saves the changes

12.6 Data and settings > Sprayer capability

Allows checking treatment performance based on speed, configurations and nozzles installed on the machine.

**WARNING:** guidance information and all accessory functions are disabled.  
 Displayed items are READ-ONLY.

See Fig. 50

Speed modification  
 + increases  
 - reduces  
 DEF:  
 6.0 km/h / 3.7 MPH

Fig. 100

Legend:

- The datum meets the specified criteria.
- The datum does NOT meet the specified criteria.

	Goes back to main screen		Goes back to previous menu, or scrolls the pages of a menu (previous page)		Quits without confirming the changes
	Saves the changes to current page		Scrolls the pages of a menu (next page)		Saves the changes

12.7 Data and settings > System

Allows checking the correct operation of the system. Groups several categories.



Displayed items are READ-ONLY.

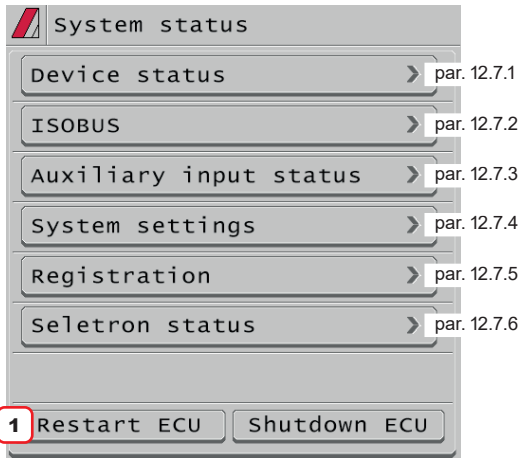

1 Press **Restart ECU** button to restart IBX100 and confirm.

Fig. 101

12.7.1 Data and settings > System > Device status

Displays system information. Page 4 displays the status of connected remote devices (e.g. Syncro...).

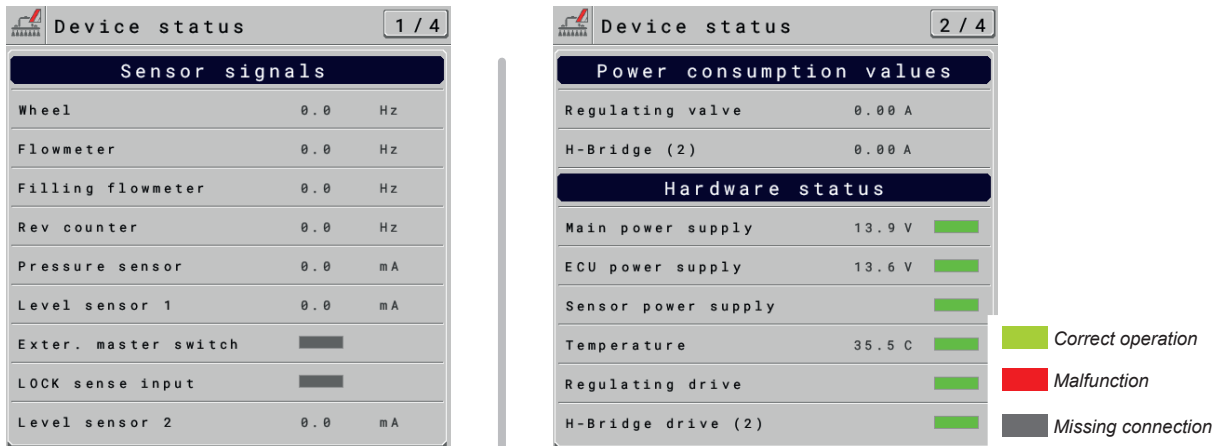

Fig. 102

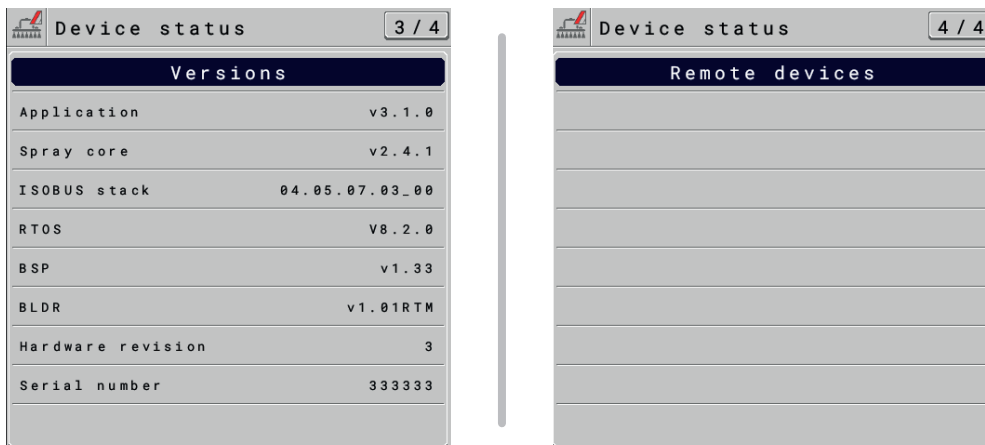
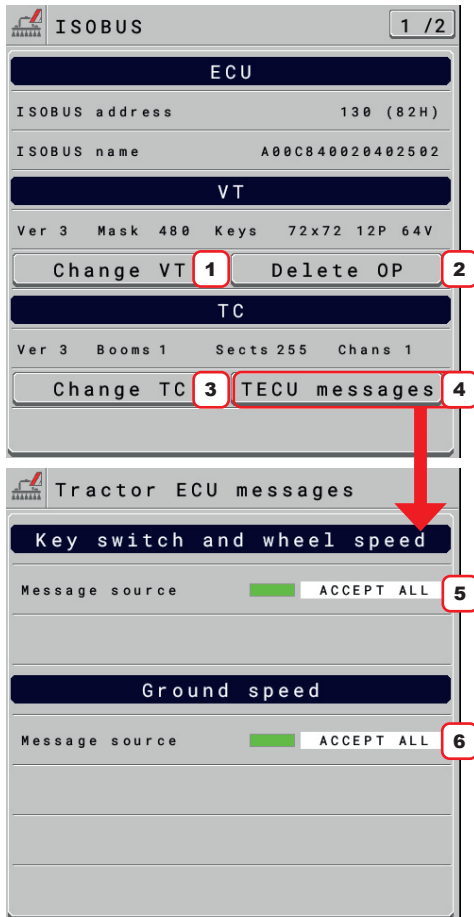

Fig. 103

	Goes back to main screen		Goes back to previous menu, or scrolls the pages of a menu (previous page)		Quits without confirming the changes
	Saves the changes to current page		Scrolls the pages of a menu (next page)		Saves the changes

12.7.2 Data and settings > System > ISOBUS



Displays information on ISOBUS protocol.

- 1 Allows changing the VT on which the OP is displayed in case more terminals are connected.
- 2 Allows deleting and reloading the ECU OP.
- 3 Allows changing the VT with which data can be exchanged through the TC in case more terminals are connected.
- 4 Allows accessing the menu for the selection of the source from which the data provided by the Tractor ECU present in the system will be received.

5 Select the source from which you wish to receive ISOBUS messages relating to system shutdown (Maintain Power) and vehicle driving speed if the latter is transmitted on the message relating to the speed of rotation of the wheel or a mechanical part of the tractor. (Home > Data and settings > Implement settings > Speed > Tractor wheel Par. 11.6).

6 Select the source from which you want to receive the ISOBUS message relevant to the vehicle driving speed if the latter is transmitted on the message relevant to the radar installed on the tractor (Home > Data and settings > Implement settings > Speed > Tractor radar Par. 11.6).

Available speed sources:

**Accept all:** IBX100 will use the data contained in the relevant messages, regardless of the source they come from.

**TECU:** IBX100 will only use the message coming from the Tractor ECU present in the system.

**VT:** IBX100 will only use the message coming from the Virtual Terminal present in the system.



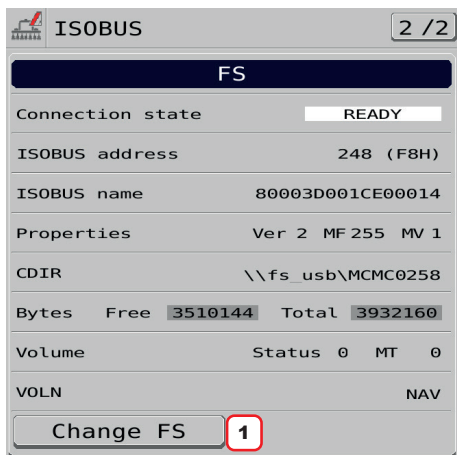



Fig. 104



It displays information about the File Server function if it is also available in the connected Virtual Terminal.

- 1 Allows changing the File Server in case more VTs are connected.

Fig. 105

	Goes back to main screen		Goes back to previous menu, or scrolls the pages of a menu (previous page)		Quits without confirming the changes
	Saves the changes to current page		Scrolls the pages of a menu (next page)		Saves the changes

12.7.3 Data and settings > System > Auxiliary input status

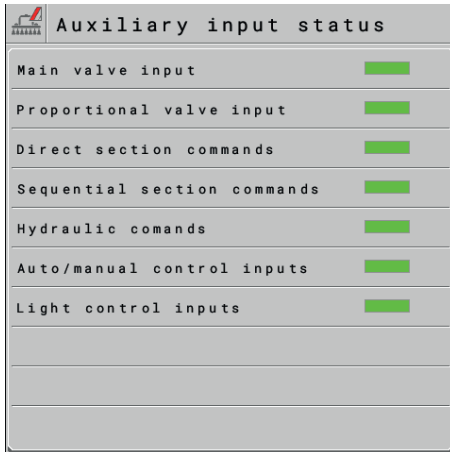

Diagnostic page related to the assignment of auxiliary functions available on IBX100.







 All auxiliary functions belonging to the category have been correctly assigned to the relevant inputs present in the installed ISOBUS switch box/joystick panel.

 No auxiliary function belonging to the category was assigned to the inputs present in the installed ISOBUS switch box/joystick panel.

 Auxiliary functions belonging to the category have been disabled and will not be made available for association with the corresponding inputs (page 40).

 Some auxiliary functions belonging to the category have been correctly assigned to the related inputs present in the installed ISOBUS switch box/joystick panel, while others have not been assigned.

Fig. 106

	Goes back to main screen		Goes back to previous menu, or scrolls the pages of a menu (previous page)		Quits without confirming the changes
	Saves the changes to current page		Scrolls the pages of a menu (next page)		Saves the changes

12.7.4 Data and settings > System > System settings

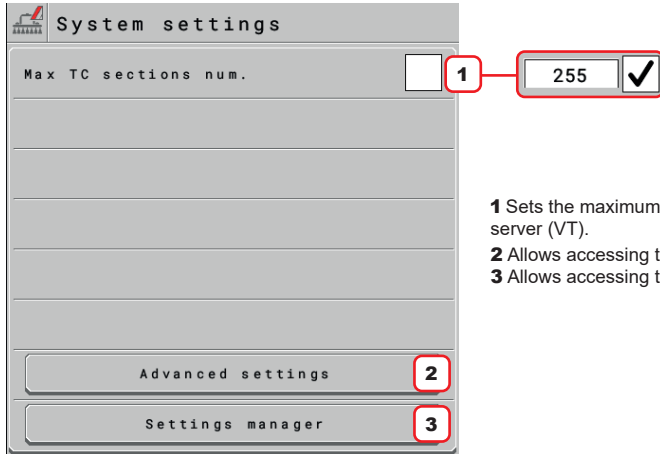

- 1** Sets the maximum number of sections of the IBX100 that can be automatically controlled by the TC server (VT).
- 2** Allows accessing the System advanced settings (see next sub-paragraph).
- 3** Allows accessing the backup management page (see next sub-paragraph).

Fig. 107

Data and settings > System > System settings> Advanced settings

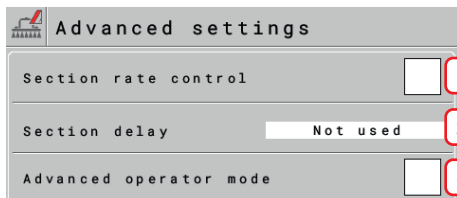

- 1** By activating this function in conjunction with TC-GEO, IBX100 will close a section upon receiving a target equal to 0l/ha for that part of the boom.
- 2** It allows setting a section opening and closing delay.  
Available options: **Not used** / **Compensation (2a)** / **Center delay (2b)**.
- 3** By enabling this function (in **Technician** mode) the application rate and the nozzles of the presets can be changed in **Operator** mode.

Fig. 108

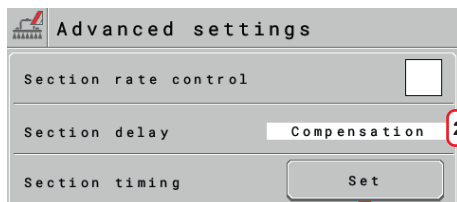

**2a**

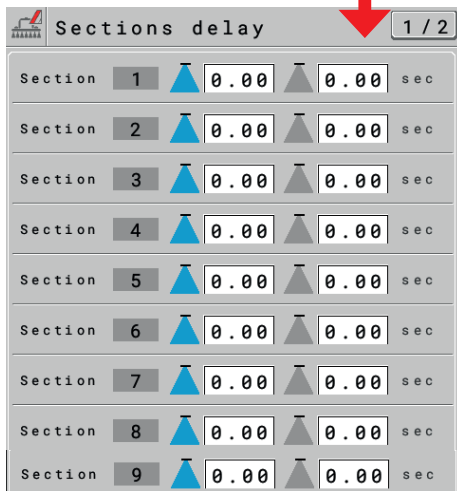

**2a Compensation:**  
allows an opening and closing delay to be set individually for each section.

Fig. 109

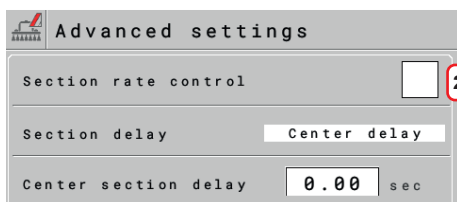

**2b**

**2b Center delay:**  
allows an opening and closing delay to be set only for center section.  
**The option is active only if your VT does not manage the boom center section Longitudinal offset geometry (set option: NO, par. 11.11 at point 5).**

Fig. 110

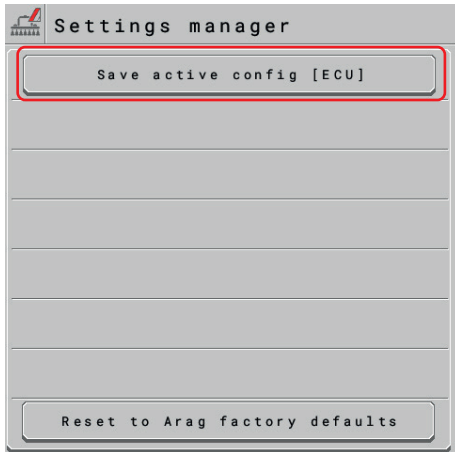

Fig. 111

Press **Save active config [ECU]** to create a backup file of the settings in use and save it to the internal memory of IBX100.



**The internal memory of IBX100 CANNOT contain more than one backup file. Press Save active config [ECU] TO OVERWRITE THE PREVIOUSLY SAVED FILE WHICH WILL BE PERMANENTLY DELETED.**



Fig. 112

Allows restoring the settings contained in the last saved backup file.

Press **Restore saved configuration [ECU]** to restore all settings in the previously saved backup file using the **Save active config [ECU]** button.

The IBX100 will restart.



**The button is only visible if a backup file was previously created and saved to the internal memory of IBX100 using the button Save active config [ECU].**



**All settings in the application menu at the time of reset WILL BE PERMANENTLY LOST.**

The backup file IS NOT DELETED after the reset.

CONTINUES



Goes back to main screen



Goes back to previous menu, or scrolls the pages of a menu (previous page)



Quits without confirming the changes



Saves the changes to current page



Scrolls the pages of a menu (next page)



Saves the changes

Data and settings > System > System settings > Settings manager > Export saved configuration [ECU]

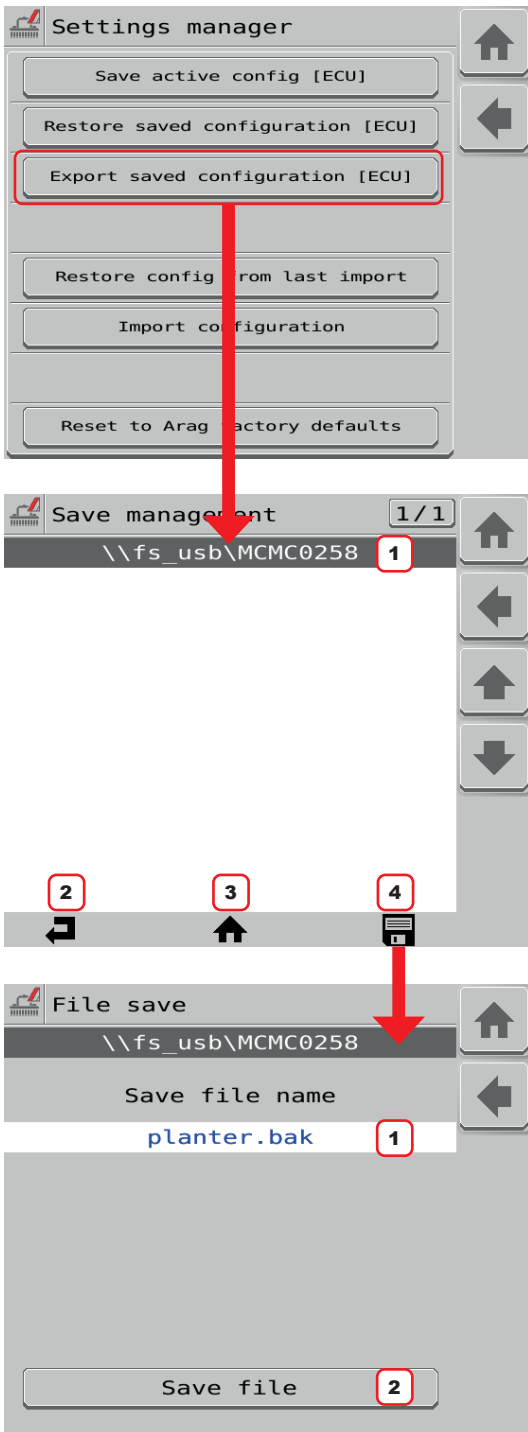



Fig. 113

Press **Export saved configuration [ECU]** to enter the File server management menu from which you can select the folder where to export the backup file (e.g. on a USB pendrive).

 **The button is visible only if the VT supports the ISOBUS File server feature.**

**1** Current folder path.

*MCMC0258 is the initial folder automatically created by the client file server and refers to ARAG because 0258 is the code that identifies ARAG as the ISOBUS component manufacturer.*

**2** BACK. Goes back to the previous folder.

**3** HOME. Returns directly to the home folder (MCMC0258) - This function may not be available in all Virtual Terminals.

**4** SAVE. Selects the current path and accesses the file saving page.







*An existing file can be overwritten by selecting it from those listed. A blue rectangle will indicate the selected file*

**1** Type the name you want to assign to the backup file to save.

**DO NOT CHANGE THE FILE EXTENSION. FILE EXTENSION MUST ALWAYS BE .bak**

*If the name assigned to the backup file to be saved is the same as that of a file already present in the selected folder, the latter will be overwritten and permanently lost.*

**2 Save file:** Saves the file to the external memory connected to the VT.

	Goes back to main screen		Goes back to previous menu, or scrolls the pages of a menu (previous page)		Quits without confirming the changes
	Saves the changes to current page		Scrolls the pages of a menu (next page)		Saves the changes



Data and settings > System > System settings > Settings manager > Import configuration

Allows importing a backup file from an external memory connected to the Virtual Terminal.

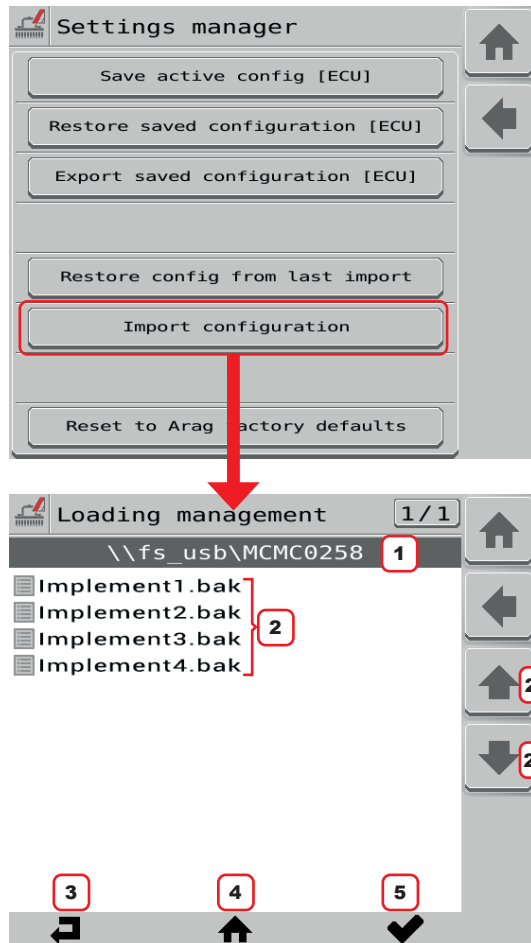

Press **Import configuration** to enter the File server management menu from which you can select the folder from which to import the backup file.

**The button is visible only if the VT supports the ISOBUS File server feature.**

- 1** Current folder path.
- 2** List of files contained within the current folder.  
*In order to be loaded, the backup file must have the extension .bak and must be inside the folder MCMC0258. This folder refers to ARAG because 0258 is the code that identifies ARAG as the ISOBUS component manufacturer.*
- 2A - 2B** Buttons to select the file to load.
- 3** BACK. Goes back to the previous folder.
- 4** HOME. Returns directly to the home folder (MCMC0258) - This function may not be available in all Virtual Terminals.
- 5** COPY. Confirms the copy of the selected backup file to the internal memory of IBX100.

Fig. 114

Data and settings > System > System settings > Settings manager > Restore config from last import.

Allows restoring the settings contained in the last imported backup file.

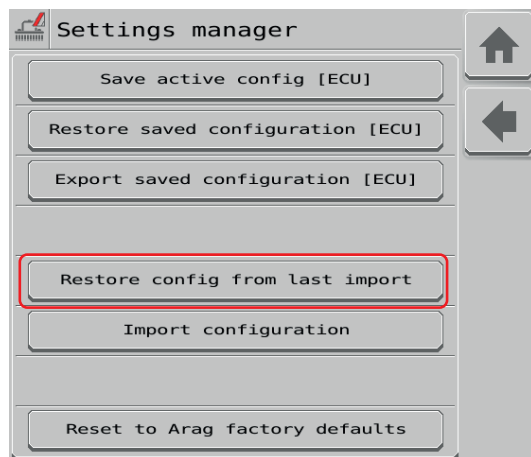

Press **Restore config from last import** to restore all settings in the previously imported backup file using the **Import configuration** button or through the relevant function available on VISIO ISOBUS.

**All settings in the application menu at the time of reset WILL BE PERMANENTLY LOST.**

**The backup file IS NOT DELETED** after the reset.

**The button is visible only if a backup file has been previously imported via the Import configuration button (see previous paragraph) or via the appropriate function available on VISIO ISOBUS**

Fig. 115

	Goes back to main screen		Goes back to previous menu, or scrolls the pages of a menu (previous page)		Quits without confirming the changes
	Saves the changes to current page		Scrolls the pages of a menu (next page)		Saves the changes

Data and settings > System > System settings > Settings manager > Reset to Arag factory defaults

Allows resetting the factory settings in the IBX100 menu.

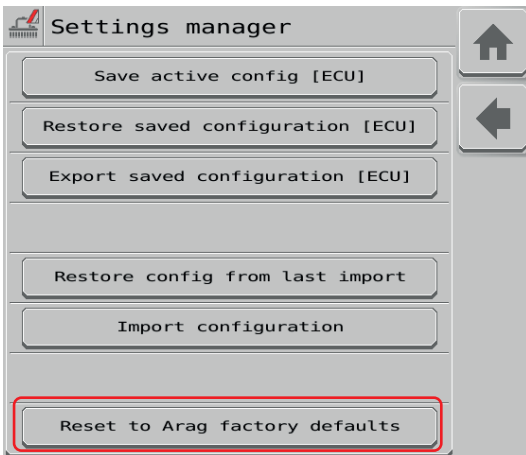



Fig. 116

Press **Reset to Arag factory defaults** to reset the IBX100 configuration to factory settings.

 **All settings in the application menu at the time of reset WILL BE PERMANENTLY LOST.**

**Any backup file previously saved via the Save active config [ECU] button or imported via the Import configuration button will not be deleted.**



Goes back to main screen



Goes back to previous menu, or scrolls the pages of a menu (previous page)



Quits without confirming the changes



Saves the changes to current page



Scrolls the pages of a menu (next page)



Saves the changes

12.7.5 Data and settings > System > Registration

Should it be necessary to re-enter the registration code supplied with the ECU, proceed as follows.

**REGISTRATION**

- 1 Press to enter registration code.
- 2 Type in the code and confirm with key 3.

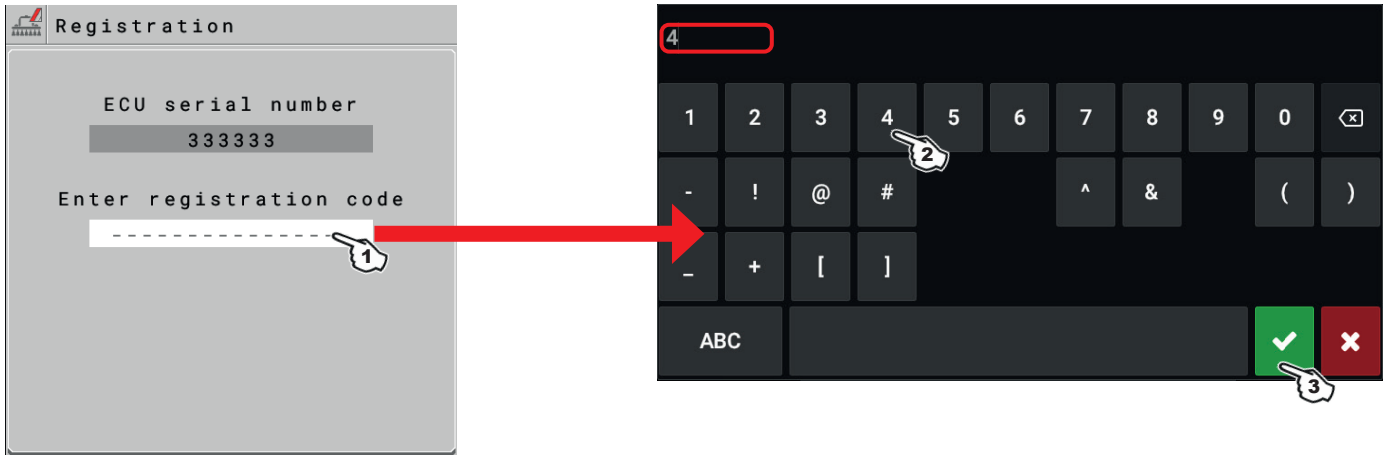

Fig. 117

12.7.6 Seletron status

This menu has two main functions:

- **INSTALLATION**  
Allows to display the progress during Seletron's pairing procedure (chap. 13 Seletron connection).
- **DIAGNOSTICS**  
Allows to check the connection of each single Seletron.



**CARRY OUT BOTH PROCEDURES WITH RUNNING ENGINE.**

**SELETRON CONNECTION DIAGNOSTICS**

**Color legend:**

- Correct operation.
- Seletron does not respond.
- Power supply error on Seletron devices: power voltage lower than the allowed value.

From screen Fig. 118 it is possible to display the relevant number.

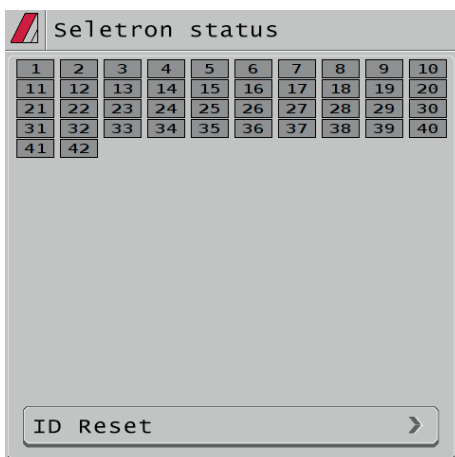

Fig. 118

**If necessary, you can and repeat the pairing procedure for each Seletron device: BEFORE STARTING A NEW PAIRING PROCEDURE, YOU MUST RESET THE PREVIOUSLY ALLOCATED IDENTIFICATION NUMBERS. Use function ID Reset (par. 13.2).**

	Goes back to main screen		Goes back to previous menu, or scrolls the pages of a menu (previous page)		Quits without confirming the changes
	Saves the changes to current page		Scrolls the pages of a menu (next page)		Saves the changes

12.8 Data and settings > User preferences

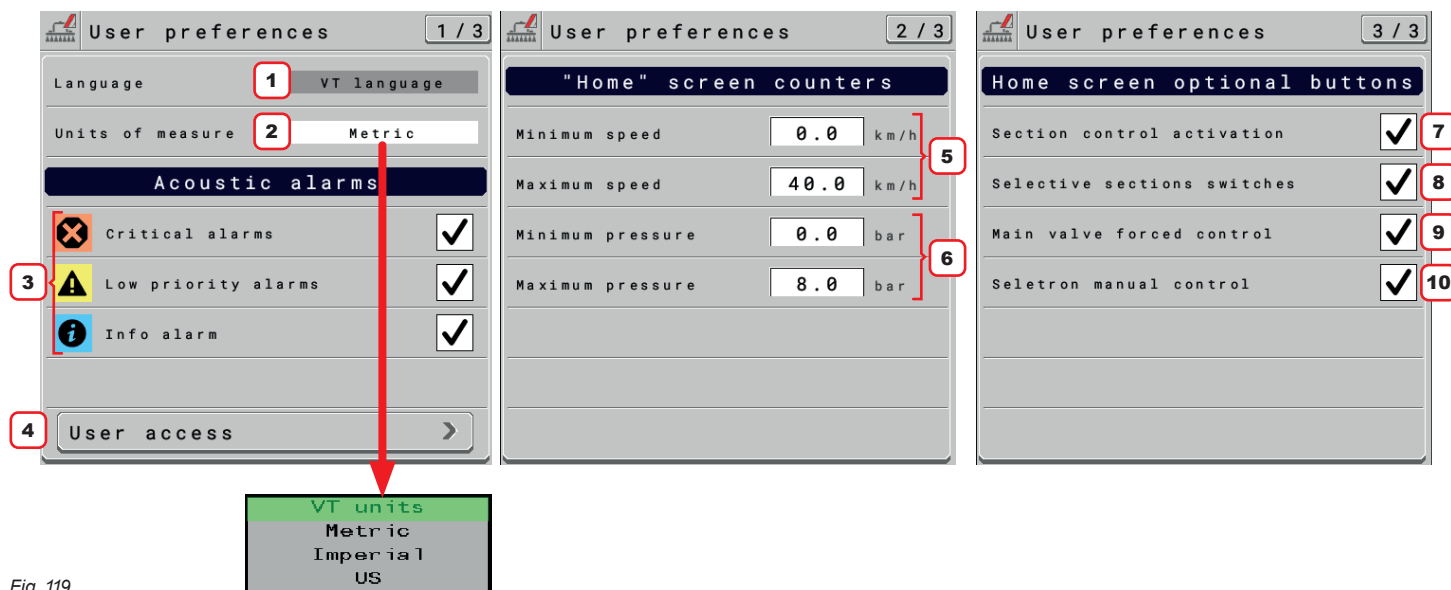

Fig. 119

1 Displays the OP use language source. To change language, edit the VT settings.

2 Set OP units of measurement.  
You can select the measurement system or infer it from the VT settings.

**ACOUSTIC ALARMS**

3 The OP has an **Info and alarms** menu, which summarizes the active notifications for the operator (par. 12.3). These notifications are rated by importance as **Critical alarms**, **Low priority alarms** and **Info**. From this screen you can enable/disable audible alerts for each notification.

**USER ACCESS**

- 4 Set OP access level.
- **Operator**: the use at this level inhibits any kind of setting. The operator only carries out the treatment.
  - **Manager**: the use at this level inhibits machine feature setting, but allows treatment configuration. You can set an access PIN code.
  - **Technician**: the use at this level allows the configuration of both machine features and treatment. You can set an access PIN code.
  - **Arag-Tech**: for ARAG staff, only.

**“HOME” SCREEN COUNTERS**

- 5 Set speed range end-value (“HOME” screen, par. 14.1).  
6 Set pressure range end-value (“HOME” screen, par. 14.1).

**HOME SCREEN OPTIONAL BUTTONS**

7 Enables / Disables the display of a function button on the main page (17.4 Home > Section control on page 80) through which you will be able to Enable / Disable the automatic section control. This input will work only after you have configured and activated the section control correctly on the Virtual Terminal in use.

8 Item available only if **Data and settings > Implement settings > System configurations > Auxiliary inputs > Type > Sequential / ARAG Joystick 1 or ARAG Joystick 2**.

Enables / Disables the display of a button (SECTION DIRECT CONTROL FROM TOUCH-SCREEN PANEL on page 74) through which you will be able to Open / Close each section selectively. It will be possible to close a center section while keeping those on the sides open.

9 Item available only if enabled **Data and settings > Implement settings > Valves > Valve settings > Main Valve > Auto closing of main valve**.

Enables / Disables the display of a button  (“HOME” page, par. 14.1) and the arrow buttons: ▲ (increases the pressure by acting on the proportional valve) / ▼ (decreases the pressure by acting on the proportional valve).

The button  forces the Opening/Closing of the main valve when it is closed by the automatic section control. **Button display is only present in manual regulation control mode.**



**WARNING: THIS FUNCTION CAN CREATE OVERPRESSURE CONDITIONS IN THE SPRAYER CIRCUIT. ONLY THE MANUFACTURER CAN ASSESS WHETHER OR NOT TO MAKE THIS INPUT AVAILABLE TO THE OPERATOR. IF SO, IT IS THE MANUFACTURER'S RESPONSIBILITY TO GIVE DIRECTIONS FOR PROPER INFORMATION/TRAINING TO THE END USER.**

**ARAG CANNOT BE HELD RESPONSIBLE FOR ANY DAMAGE CAUSED BY THE ACTIVATION OF THIS FUNCTION SINCE ONLY THE MANUFACTURER IS AWARE OF THE CHARACTERISTICS OF THE SYSTEM DESIGNED AND ON WHICH THE IBX100 SPRAYER ISOBUS IS INSTALLED.**

10 Item available only if **Data and settings > Implement settings > Basic settings > Seletron**. Enables / Disables the display of a button on the main page (17.2 Home > Seletron manual control on page 80) through which it will be possible to access a page where inputs to manually Open / Close each Seletron valve individually will be displayed. Closing a Seletron in manual mode will have priority over automatic section control.

13 SELETRON CONNECTION

PLEASE CAREFULLY FOLLOW THE INSTRUCTIONS PROVIDED IN THIS CHAPTER. ANY MISTAKE DURING SELETRON PAIRING/REPLACEMENT MAY LEAD TO SYSTEM OPERATION FAILURE.

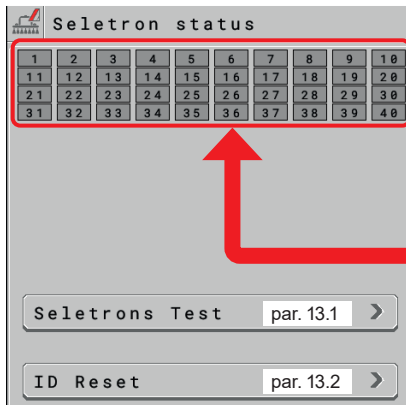





Fig. 120

**BEFORE PROCEEDING, MAKE SURE YOU ARE ABLE TO HEAR THE ACOUSTIC SIGNALS COMING FROM THE MONITOR LOCATED IN THE CABIN (DOORS OPEN, ETC.).**

• Access the menu (par. 12.7.6)  
**Data and settings > System > Seletron status**

• Make sure that ALL SELETRON DEVICES ARE DISCONNECTED: they must be shown on the display only with the symbols , as shown in Fig. 120.

-  Seletron does not respond.
-  Power supply error on Seletron devices: power voltage lower than the allowed value.
-  Correct operation.

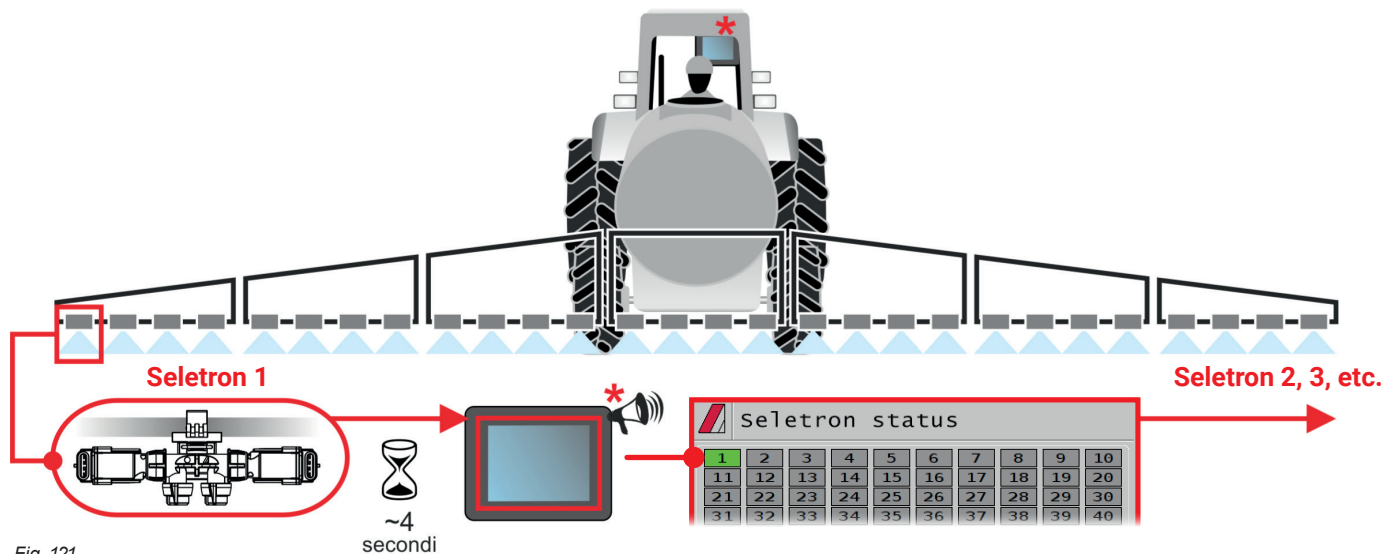



Fig. 121

**BEFORE CONNECTING A NEW SELETRON, MAKE SURE THAT THE PREVIOUS ONE HAS BEEN PAIRED, that the acoustic signal has been made and that the relevant green symbol has been displayed.**

In case of errors during the pairing procedure, (the display shows the symbol ) reset all identification numbers and repeat the procedure from the start (ID Reset, par. 13.2).

• Connect the first Seletron.

Seletron no. 1 is the first on the left, when looking at the boom from behind (Fig. 121).

**WAIT FOR THE ACOUSTIC SIGNAL BY THE MONITOR. WAIT FOR THE MONITOR TO DISPLAY THE GREEN SYMBOL FOR THE CONNECTED SELETRON (FIG. 121).**

• **ONLY NOW** is it possible to proceed with the installation of the following Seletron.

**WARNING: ALL SELETRON DEVICES MUST BE INSTALLED IN A SEQUENCE FROM LEFT TO RIGHT (when looking at the boom from behind).**

- Repeat the above steps, connecting all remaining Seletron devices from left to right until the end of the boom.
- Connection sequence in presence of end nozzles (par. 17.1):

**“BUFFER ZONE” NOZZLES**

start by connecting the “Buffer zone” Seletron, which is located on boom left end, then connect all the “standard” Seletrons in their correct order from left to right and, at last, connect the “Buffer Zone” Seletron located on boom right end.

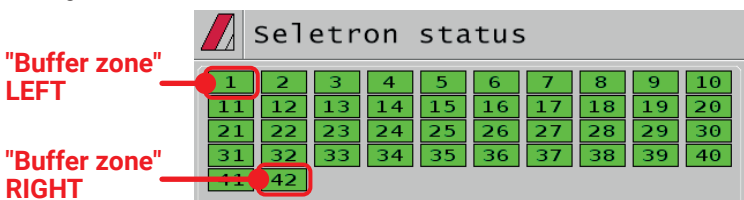

**“FENCE” NOZZLES**

start by connecting all “standard” Seletrons in their correct order from left to right, then connect the “Fence” Seletron located on boom left end and, at last, connect the “Fence” Seletron located on boom right end.

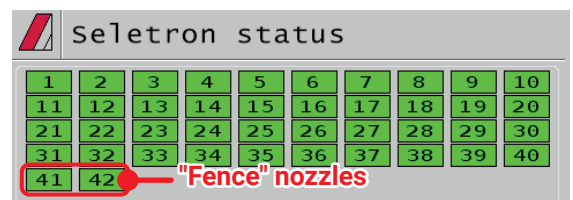

CONTINUES >>>

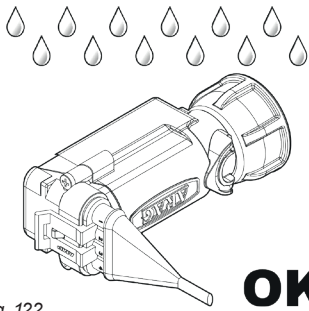
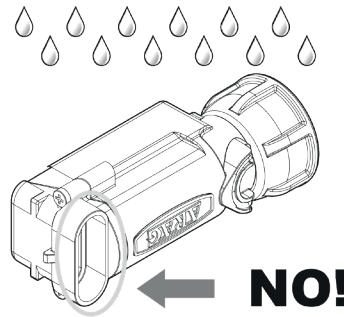

Fig. 122



The products are supplied with valve installation instructions.  
 Make sure the device is correctly fitted and push it until locking it. When the cable is inserted in the connector, the Seletron is sealed.  
 To avoid damaging the internal components, make sure that when using or cleaning the system the connectors are not bare or inserted incorrectly.

**CONNECTION SEQUENCE FOR SINGLE AND TWIN SELETRON DEVICES**

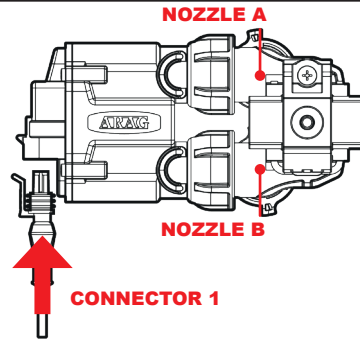

Fig. 123

Connect all Seletron devices in sequence, from left to right until the end of the boom.

**CONNECTION SEQUENCE FOR FOURFOLD SELETRON DEVICES**

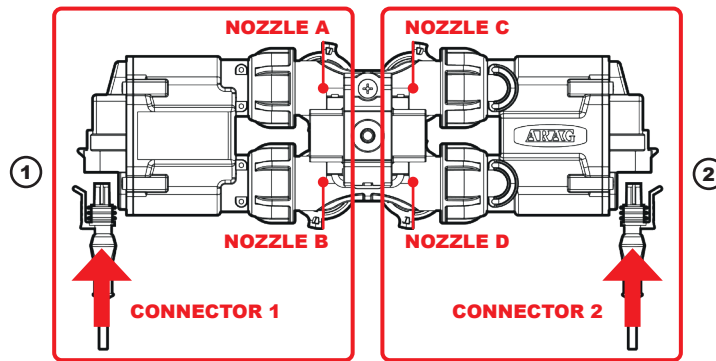

Fig. 124

- 1 Connect in sequence **ONLY SELETRON NOZZLE HOLDERS A AND B**, from left to right until the end of the boom (**connector 1** in Fig. 124).
- 2 Start again from the beginning: this time connect **SELETRON NOZZLE HOLDERS C AND D**, from left to right until the end of the boom (**connector 2**).



Goes back to main screen



Goes back to previous menu, or scrolls the pages of a menu (previous page)



Quits without confirming the changes



Saves the changes to current page



Scrolls the pages of a menu (next page)



Saves the changes

13.1 Seletrons Test

Test page to check the operation of the Seletrons. The menu allows choosing the **Automatic** mode: **Off / Fast / Medium / Slow**.

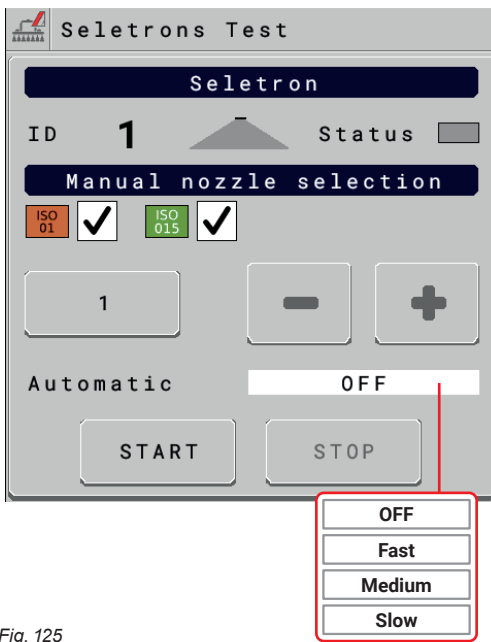

By pressing **START** the system allows the single selected Seletron spraying. Use buttons+ and - to select the Seletron to be tested (- previous Seletron, + next Seletron)

**Nozzle manual selection**

Allows you to Deactivate / Activate each individual nozzle, available from those preselected in the currently active **Preset**. In case you attempt to deactivate both nozzles, the system will automatically reactivate the first nozzle on the left (in the Fig. 125 the nozzle that will be reactivated is the orange 01).

**Function ONLY available if Data and settings > Implement settings > Basic settings > Spraying point type > 2 or 4.**

1

It restores selection: it starts again from Seletron with ID1.

There are two testing modes:

- **Automatic > OFF:** by pressing **Start** the system allows the single selected Seletron spraying.
- **Automatic > Fast / Medium / Slow:** by pressing **Start** the system allows all Seletrons installed on the boom to spray, one at a time.



- The pump must be running to perform the test.
- The test can also be performed with Task Controller or Section Control activated.

Fig. 125

13.2 ID Reset

Allows to reset the identification numbers of all saved Seletrons, before repeating the pairing procedure (chap. 13).

**TO PREVENT SYSTEM MALFUNCTIONS, THIS OPERATION MUST BE CARRIED OUT ONLY IF STRICTLY NECESSARY**

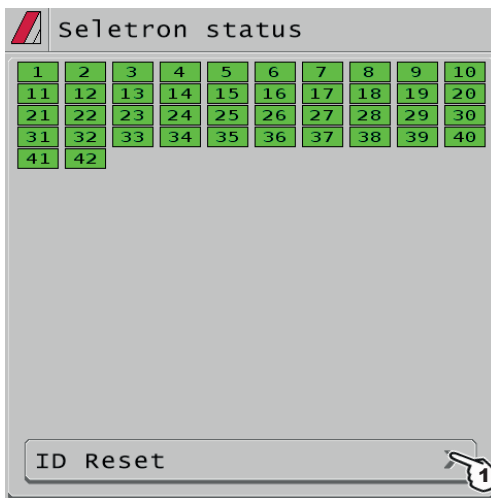

Press key **1** to delete identification numbers. Press key **2** to confirm.

**At the end of the reset procedure, DISCONNECT ALL SELETRON DEVICES and start a new pairing procedure (chap. 13).**



Fig. 126

	Goes back to main screen		Goes back to previous menu, or scrolls the pages of a menu (previous page)		Quits without confirming the changes
	Saves the changes to current page		Scrolls the pages of a menu (next page)		Saves the changes

13.3 SELETRON REPLACEMENT

13.3.1 Preliminary Operations

**⚠ TO AVOID ACCIDENTS, EMPTY THE TANK AND MAKE SURE THAT THE ENTIRE SYSTEM IS COMPLETELY FREE FROM CHEMICALS.**

**IMPORTANT**

Operate main valve and section controls (ON position) and carry out the indicated settings:

General control ON + Open sections + Active nozzles + **MANUAL** nozzle selection + **MANUAL** section management

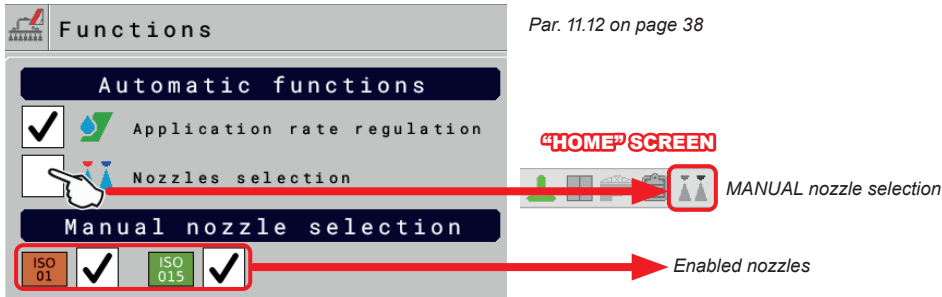

Fig. 127

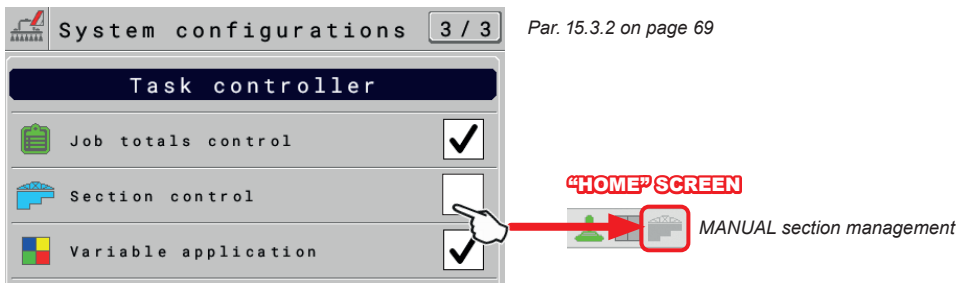

Fig. 128

13.3.2 Replacement procedure

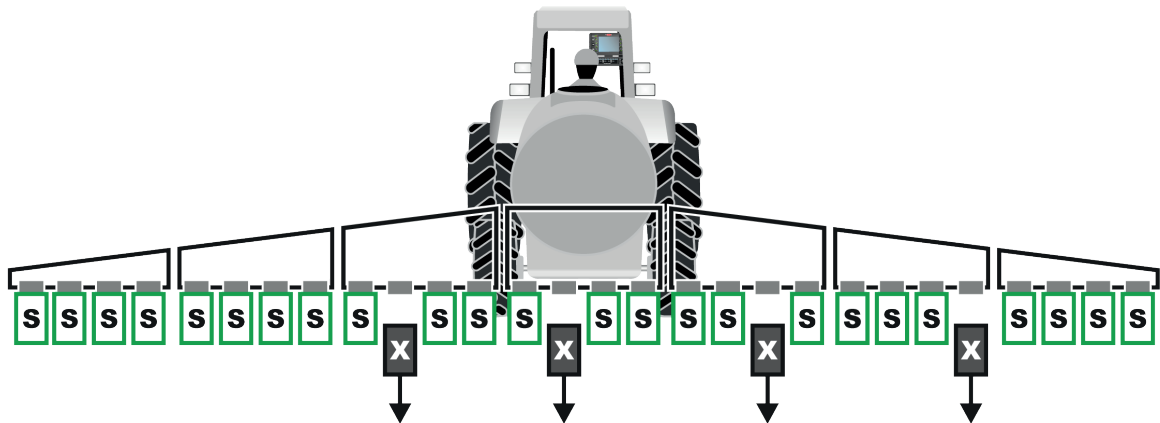
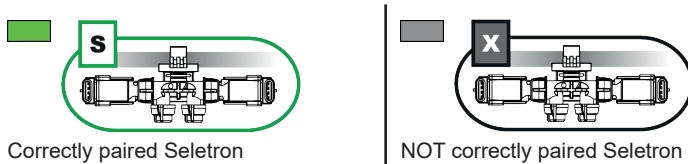

Fig. 129



- ONLY DISCONNECT THE SELETRON DEVICES THAT WERE NOT CORRECTLY PAIRED (  Fig. 129).

CONTINUES >>>



Connect the new Seletron devices: \* Fig. 130, IN A SEQUENCE FROM LEFT TO RIGHT (when looking at the boom from behind).

 AFTER CONNECTING THE SELETRON, WAIT FOR APPROX. 4 SECONDS, THE MONITOR MAKES AN ACOUSTIC SIGNAL AND DISPLAYS THE GREEN SYMBOL OF THE CONNECTED SELETRON. **ONLY NOW IS IT POSSIBLE TO PROCEED WITH THE INSTALLATION OF THE FOLLOWING SELETRON.**

Tighten each Seletron onto the relevant nozzle holder, using a torque wrench and a tightening torque of 4.5 Nm / 40 Inch/lbs. Alternatively, if you do not have a torque wrench, tighten the Seletron devices by hand and make sure there are no leaks.

 ARAG IS NOT LIABLE FOR ANY DAMAGE OR MALFUNCTION CAUSED BY THE USE OF TOOLS DIFFERENT FROM THE ONES INDICATED ABOVE.

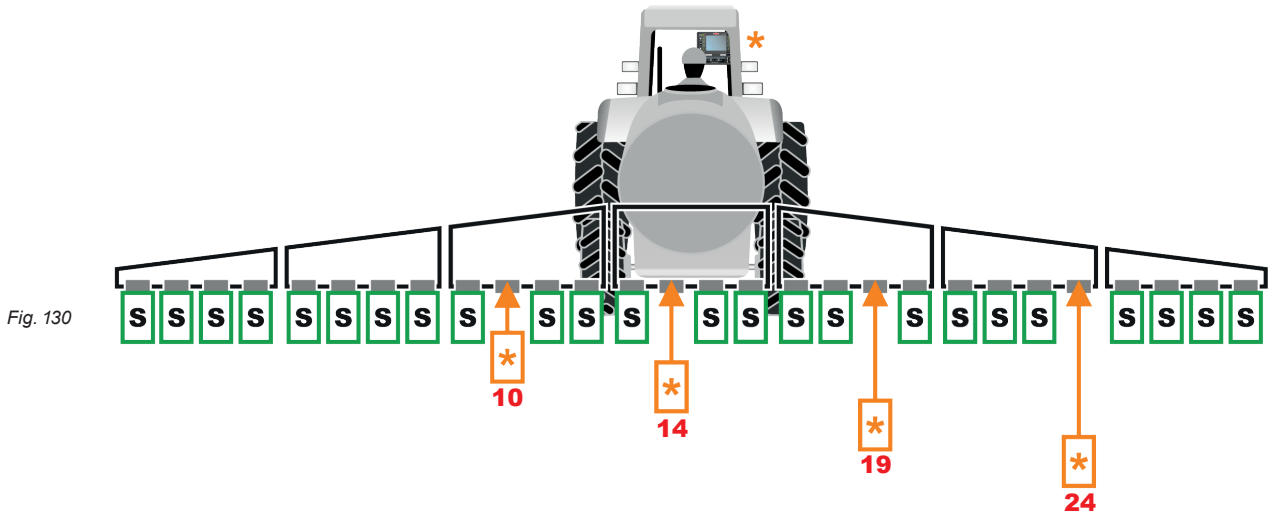
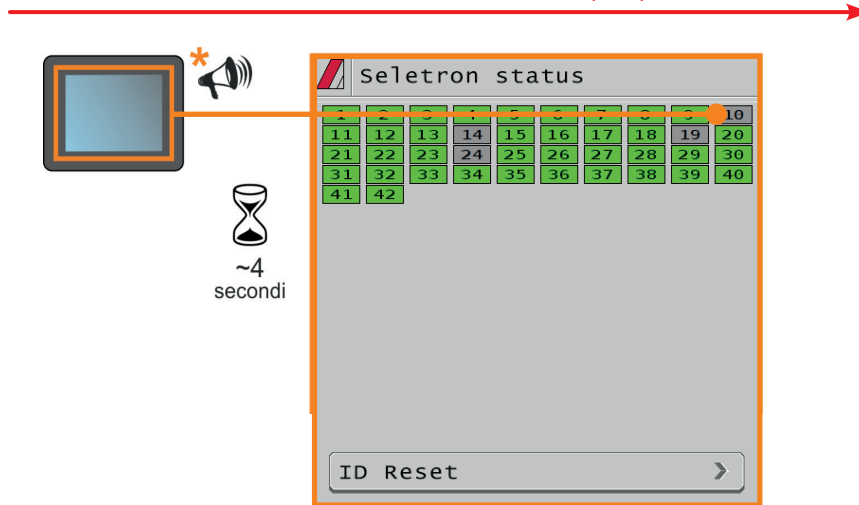

Fig. 130

**SELETRON CONNECTION SEQUENCE: 10, 14, 19 AND 24**



Goes back to main screen



Goes back to previous menu, or scrolls the pages of a menu (previous page)



Quits without confirming the changes



Saves the changes to current page



Scrolls the pages of a menu (next page)



Saves the changes

14 USE

14.1 "HOME" main screen

MENU SELECTION BUTTONS

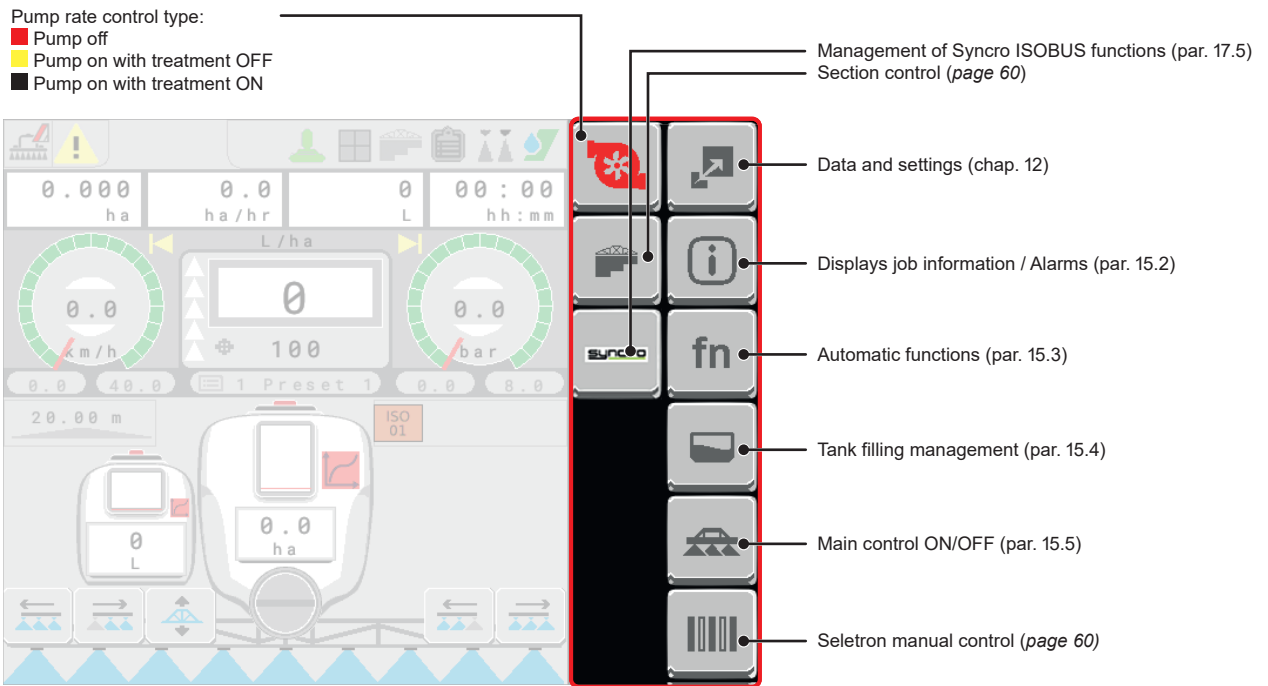

DISPLAY ITEMS

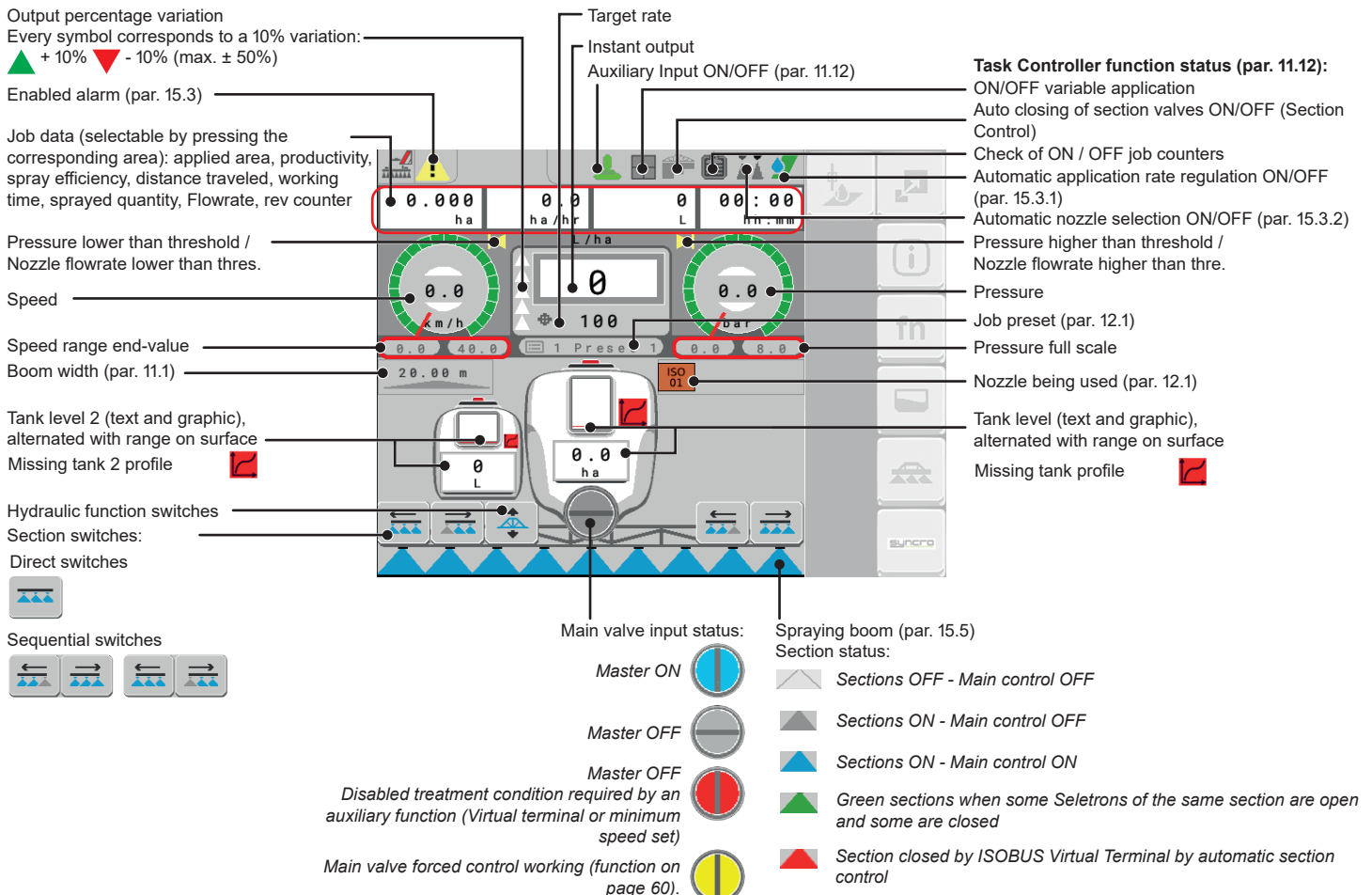

15 JOB FUNCTIONS

15.1 Output temporary increase and decrease - Home page > Change target rate

Change the target rate value for the job.

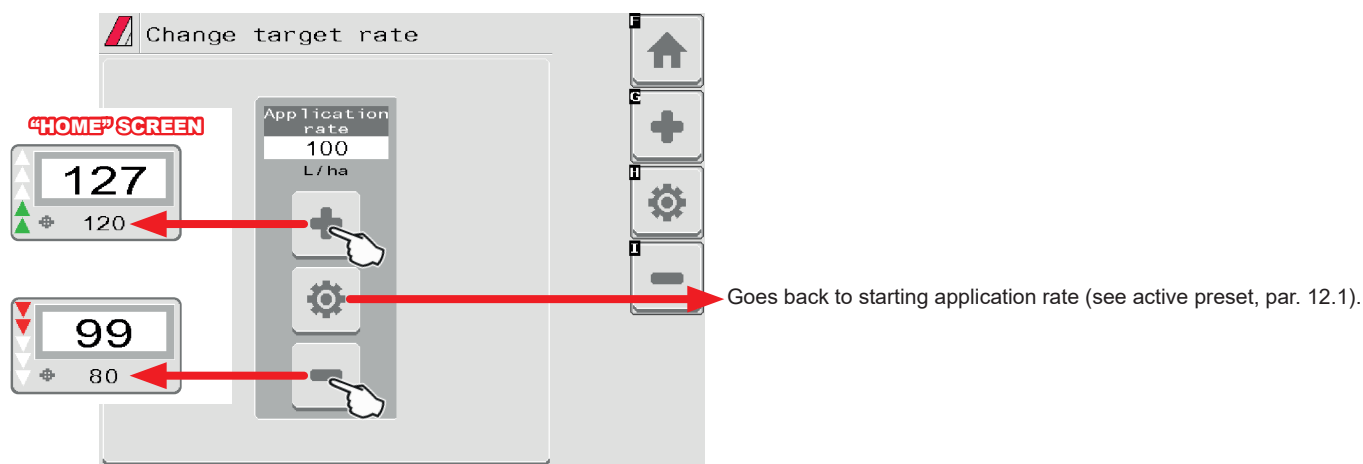



Fig. 131

15.2 Home > Alarms

From "Home" screen, press .  
This screen summarizes the alarm notifications active for the operators or the just-solved alarms.

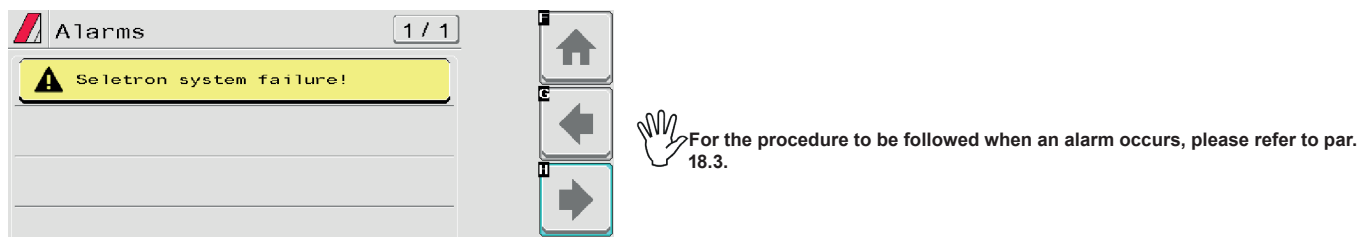







Fig. 132

	Goes back to main screen		Goes back to previous menu, or scrolls the pages of a menu (previous page)		Quits without confirming the changes
	Saves the changes to current page		Scrolls the pages of a menu (next page)		Saves the changes

15.3 Home > Automatic functions

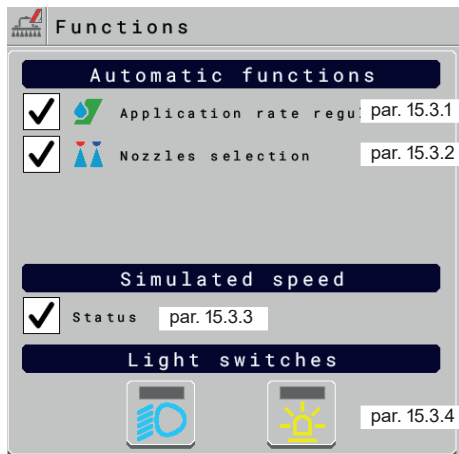



Fig. 133

From "Home" screen, press 

15.3.1 Home > Automatic functions > Application rate regulation

Enables / disables automatic output adjustment (DEFAULT: ON).

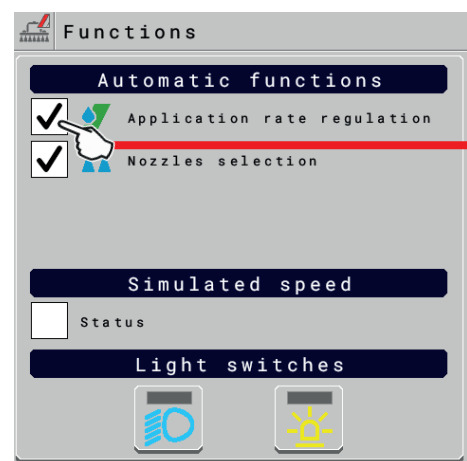
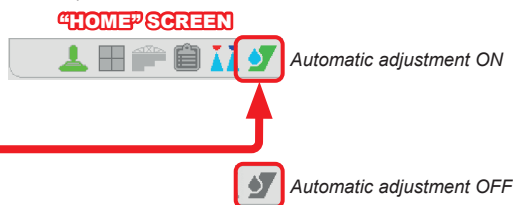







Fig. 134



**AUTOMATIC ADJUSTMENT ON**  
 IBX100 keeps the set application rate constant regardless of the changes in speed and boom section status.  
 In this case the application rate can be set with the proper functions **Manage presets** (par. 12.1) - **Change target rate** (par. 15.1), or by loading a prescription map from TC.

If necessary, during spraying, it is possible to intervene on output control (Auxiliary Input) to adjust output to crop conditions, increasing or decreasing momentarily the application rate up to  $\pm 50\%$ .

**AUTOMATIC ADJUSTMENT OFF (MANUAL)**  
 Rate manual regulation shall be carried out with the suitable command (Auxiliary Input).

	Goes back to main screen		Goes back to previous menu, or scrolls the pages of a menu (previous page)		Quits without confirming the changes
	Saves the changes to current page		Scrolls the pages of a menu (next page)		Saves the changes

15.3.2 Home > Automatic functions > Nozzles selection

Enables / disables automatic nozzle selection on all spraying points (DEFAULT: ON).

**AUTOMATIC NOZZLE SELECTION**

When spraying starts (general command ON), VT automatically checks the flowrates: if the necessary conditions are not met, VT signals this with the screen of Fig. 137.

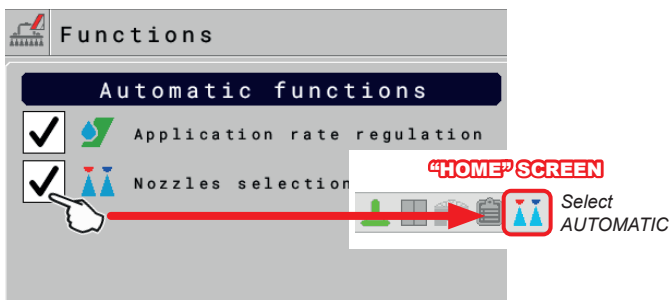

Fig. 135

**MANUAL NOZZLE SELECTION**

Allows to select manually nozzles in use on the spraying points. The number of nozzles displayed will vary according to the spraying point setting (par. 10). Press the button next to the nozzle to enable or disable the corresponding nozzle.

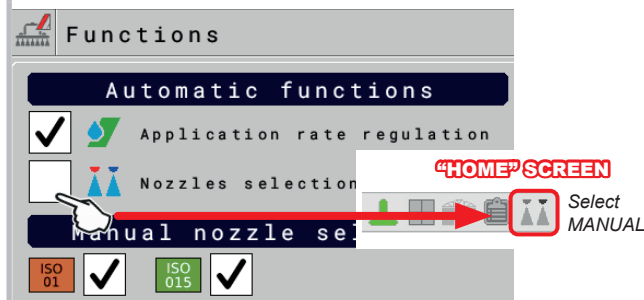

Fig. 136

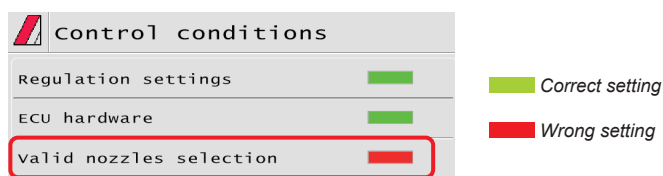

Fig. 137

**HOW THE AUTOMATIC NOZZLE SELECTION WORKS (SELETRON and DUAL BOOM SYSTEM)**

In a traditional system, the farming machine speed limits depend on the minimum and maximum pressure of the nozzle in use and on the desired spray rate. For instance, if we were spraying 100 l/ha with a violet evenfan nozzle ISO110025, the minimum operating speed shall be 6.9 km/h (corresponding to a pressure of 1 bar) while maximum speed shall be 13.9 Km/h (corresponding to a pressure of 4 bars). This operation field can be restrictive for the features of both crop to be treated and machine.

**Operation field of possible combinations of ISO11002 and ISO110025 nozzles**

When automatic nozzle selection is enabled, the VT (using Seletron devices) will enable the nozzle, or combination of nozzles, according to the set spray rate and driving speed.

This system allows to widen the machine operating range, i.e. in the above instance, using ISO11002 yellow (A) and ISO110025 violet (B) nozzles, that work correctly at a speed from 5.5 km/h to 24.9 km/h.

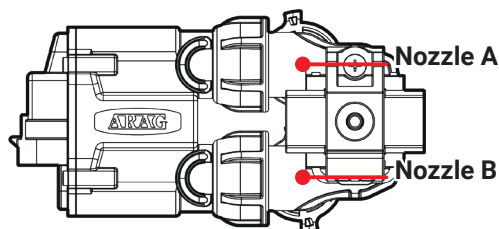

Fig. 138

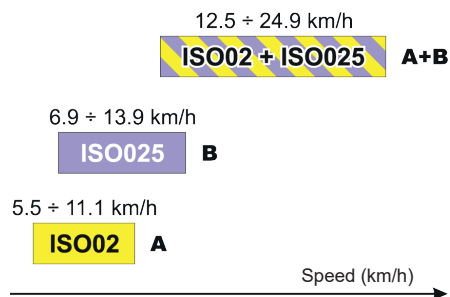

Fig. 139

According to the set data and those detected by the sensors, the monitor selects the suitable nozzle configuration constantly checking that:

- the spraying pressure always remains within the job features set for each single nozzle
- in case of many possible nozzle configurations, the operating pressure of the configuration in use is as close as possible to the operating range of the nozzle
- required number of nozzle changes is as low as possible.

When setting a spraying, make sure to couple compatible nozzles.

For example:

• **Compatible nozzles:** the flowrate at 1 bar of the ISO025 nozzle is LOWER than the flowrate at 5 bars of the ISO02 nozzle (Fig. 140).

• **NON-compatible nozzles:** the flowrate at 1 bar of the ISO05 nozzle is HIGHER than the flowrate at 5 bars of the ISO02 nozzle (Fig. 141).

In the same way, the overall flowrate of both nozzles at MINIMUM pressure shall be LOWER than the flowrate of the high flowrate nozzle at MAXIMUM pressure.

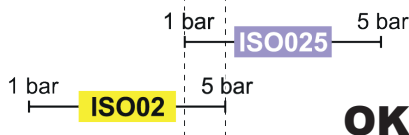

Fig. 140

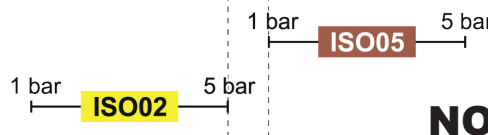

Fig. 141



Goes back to main screen



Goes back to previous menu, or scrolls the pages of a menu (previous page)



Quits without confirming the changes



Saves the changes to current page



Scrolls the pages of a menu (next page)



Saves the changes

15.3.3 Home > Automatic functions > Simulated speed

Allows enabling / disabling speed simulation (DEFAULT: OFF).

The simulation allows carrying out regulation tests with stopped machine (default presetting at 6 km/h - 3.7 MPH).

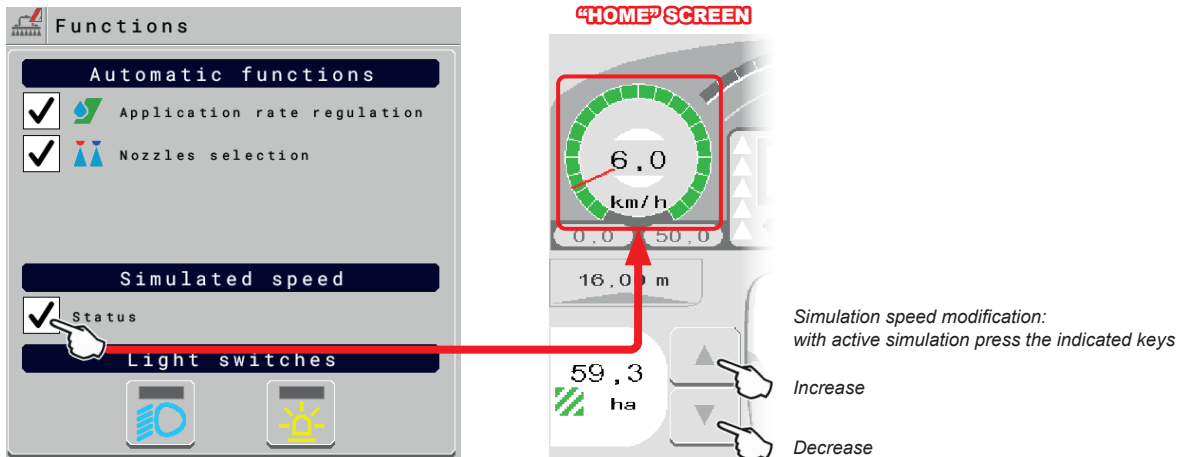

Fig. 142

15.3.4 Home > Automatic functions > Light switches

Allows turning on/off the installed light switches (DEFAULT: OFF).

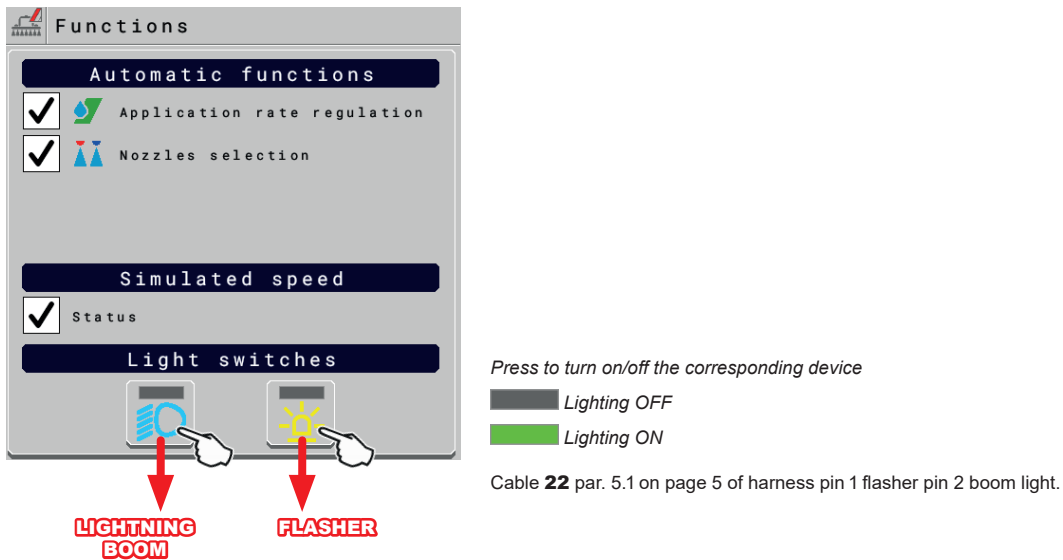









Fig. 143

	Goes back to main screen		Goes back to previous menu, or scrolls the pages of a menu (previous page)		Quits without confirming the changes
	Saves the changes to current page		Scrolls the pages of a menu (next page)		Saves the changes

15.4 Home > Tank

Manages tank filling. The management mode will change according to the device set for the tank level reading (chap. 10).

From "Home" screen, press 

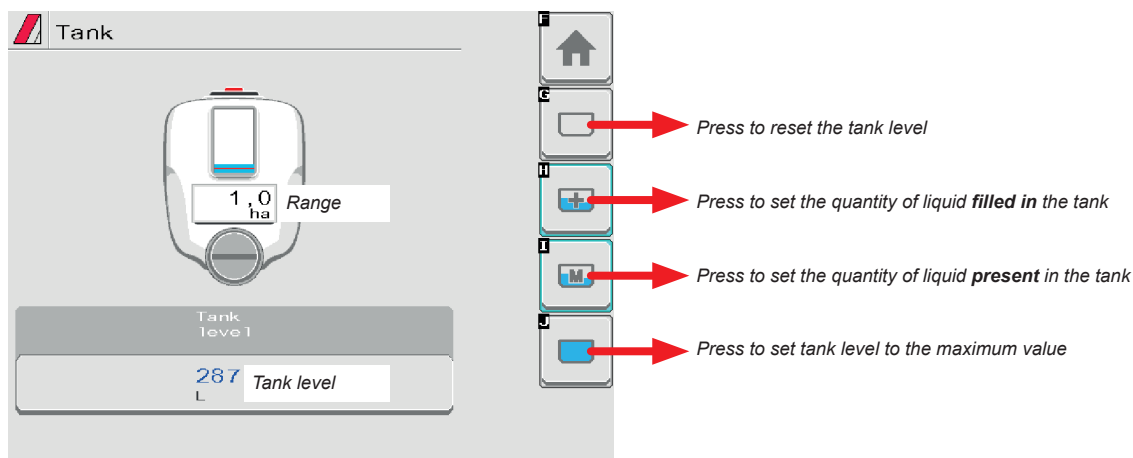

Fig. 144

• **Tank level source: Single tank level**

The computer displays the real quantity of fluid inside the tank, detected by the level sensor.

• **Tank level source: Manual / Filling flowmeter**

The computer calculates the quantity of fluid inside the tank (by processing the job data), and allows to enable several manual procedures:

- Level reset.
- Filled quantity manual setup.
- Tank level manual setting.
- Complete filling, according to the tank capacity.

**LEVEL RESET**

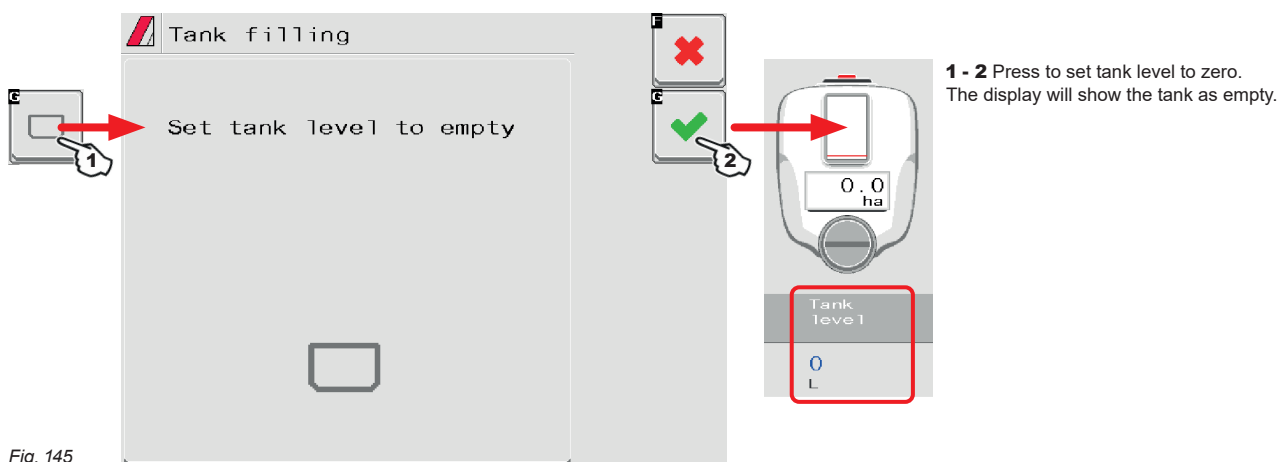

Fig. 145

**FILLED QUANTITY MANUAL SETUP**

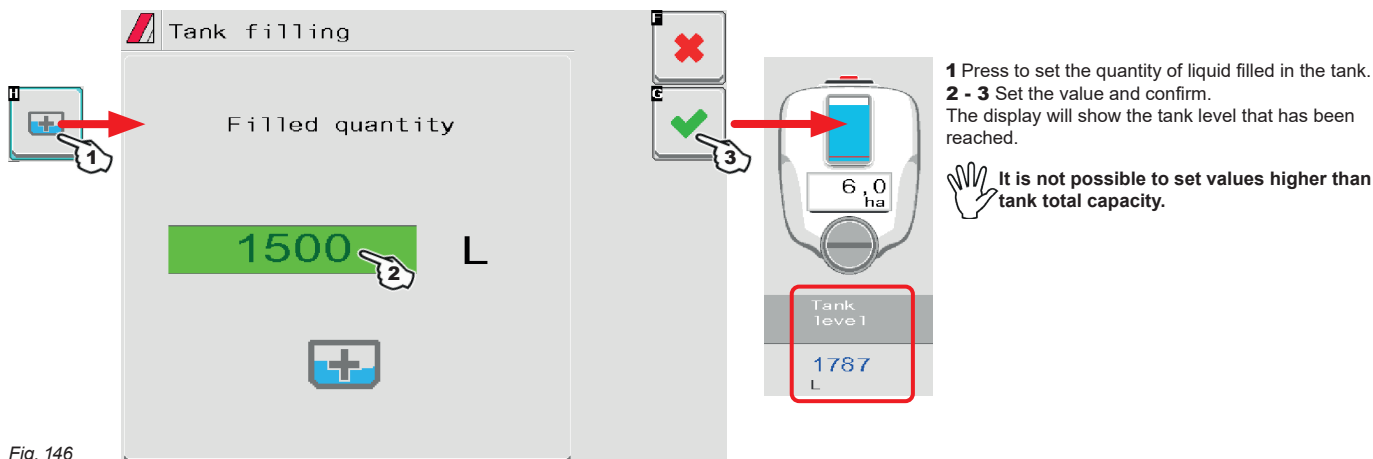

Fig. 146

CONTINUES

TANK LEVEL MANUAL SETTING

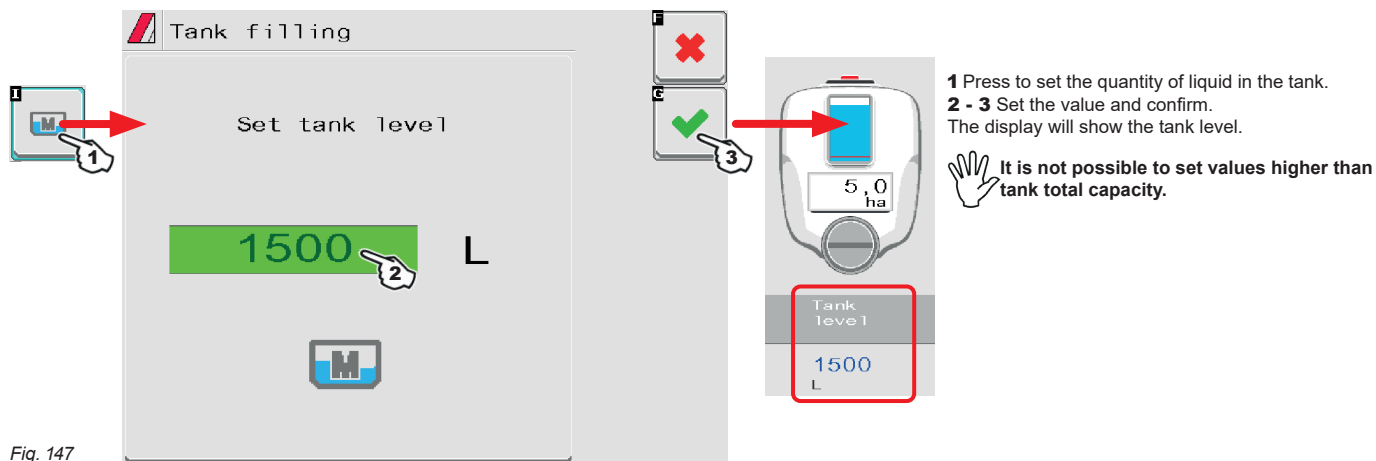

Fig. 147

TANK FILLING

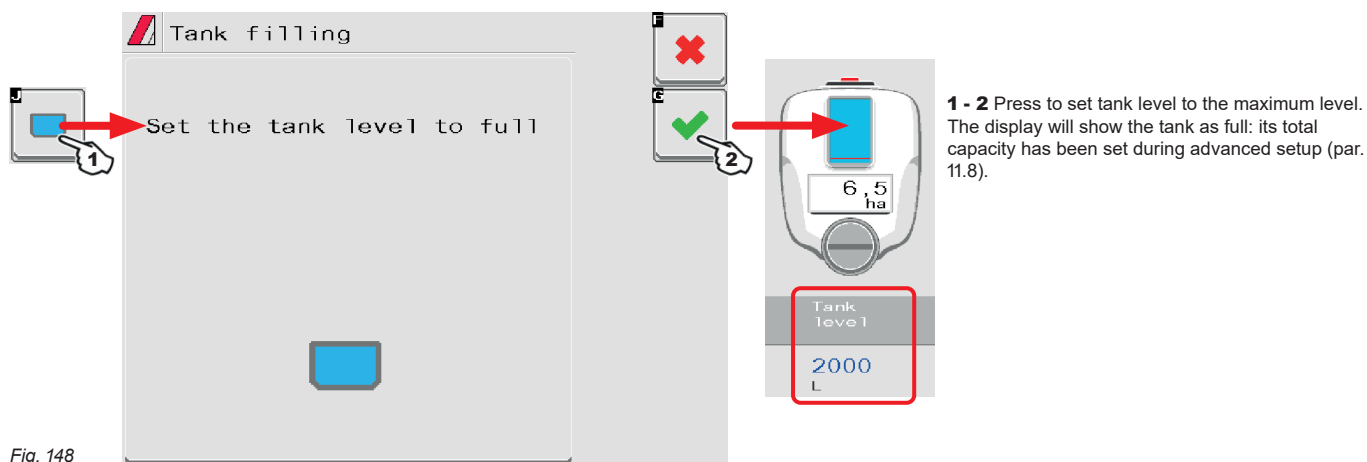







Fig. 148

	Goes back to main screen		Goes back to previous menu, or scrolls the pages of a menu (previous page)		Quits without confirming the changes
	Saves the changes to current page		Scrolls the pages of a menu (next page)		Saves the changes



15.5 Main control and section management

15.5.1 Control settings WITH Auxiliary Input

Refer to the user's manual supplied with the device.



Type	Sequential	HYD	9	0
Using center section switch	YES			7
				NO

Type	Direct	HYD	9	0
Number of section switches	7			7

ARAG Auxiliary Input control system is not compulsory on all systems, and must thus be ordered separately. Some VTs allow controlling section valves directly from monitor touch-screen panel.

To display the necessary controls on the touch-screen panel, your auxiliary input must nevertheless be set (par. 11.12).

If the hydraulic valve management is handled by IBX100 Hydraulic Isobus, select zero as HYD value.

Type	ARAG Joystick 1	HYD	9	0
				7

Type	Arag joystick 2	HYD	9	0
Number of pages	2			7
				1

Type	Hydraulic only	HYD	9	0
				7

15.5.2 Control settings WITHOUT Auxiliary Input



Type	Direct	HYD	9	0
Number of section switches	7			7

If no Auxiliary Input is present, the valves are controlled (control unit and/or hydraulic valves) directly through the monitor touch-screen panel (keys in the bottom part of the HOME page).

To display the necessary controls on the touch-screen panel, your auxiliary input must nevertheless be set (par. 11.12).

If the hydraulic valve management is handled by IBX100 Hydraulic Isobus, select zero as HYD value.

Type	Sequential	HYD	9	0
Using center section switch	YES			7
				NO

Type	ARAG Joystick 1	HYD	9	0
				7

Type	Arag joystick 2	HYD	9	0
Number of pages	2			7
				1

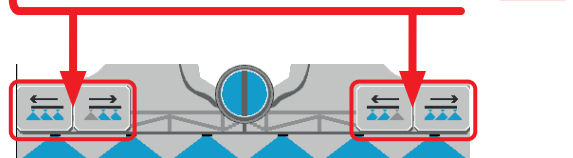

MAIN CONTROL FROM TOUCH-SCREEN PANEL

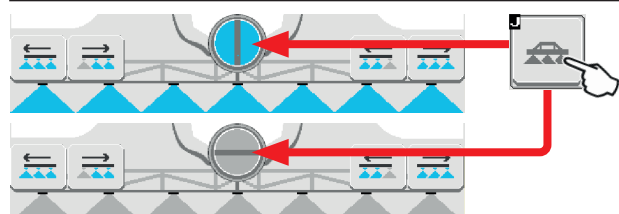

Press key to enable or disable the main control.



**SECTION DIRECT CONTROL FROM TOUCH-SCREEN PANEL**

Press button to display the **Section switches** page

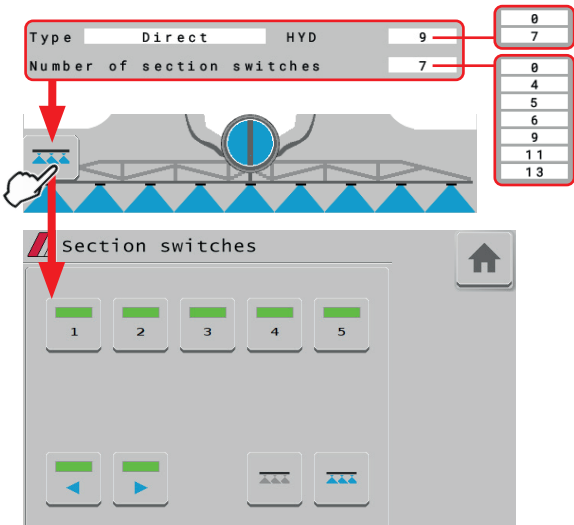

- Press to open/close the relevant section

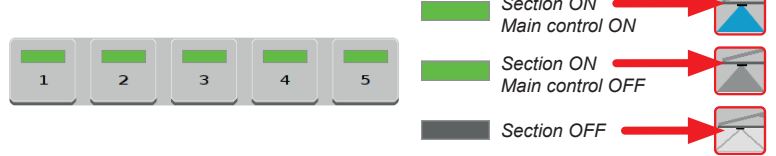

- Press to open/close the relevant end nozzle

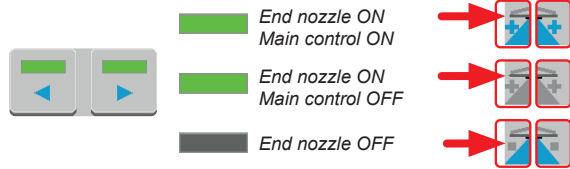





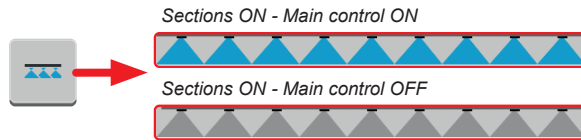

- Press to close all boom sections



- Press to open all boom sections



CONTINUES

	Goes back to main screen		Goes back to previous menu, or scrolls the pages of a menu (previous page)		Quits without confirming the changes
	Saves the changes to current page		Scrolls the pages of a menu (next page)		Saves the changes

**SECTION SEQUENTIAL CONTROL FROM TOUCH-SCREEN PANEL**

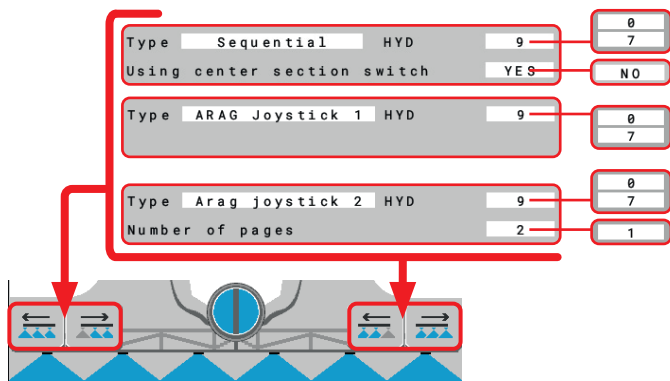

Press button to open sections to the left, starting from the first available on the right.

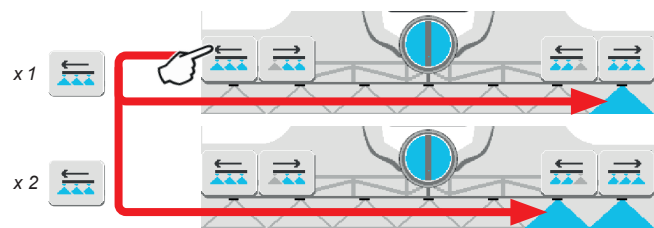

Press button to open sections to the right, starting from the first available on the left.

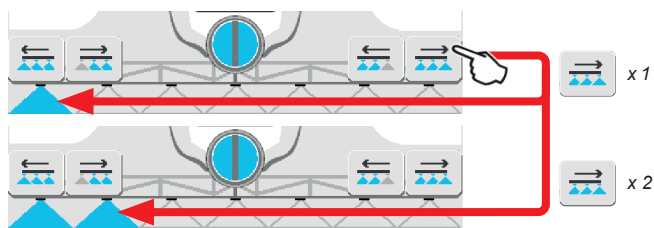

Press button to close sections to the right, starting from the first available on the left.

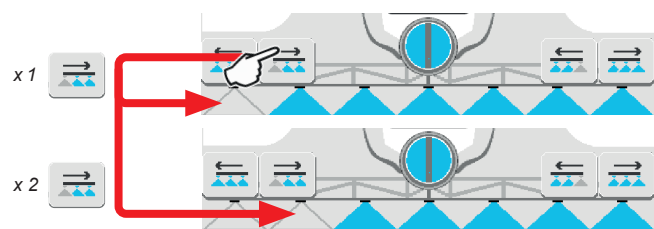

Press button to close sections to the left, starting from the first available on the right.

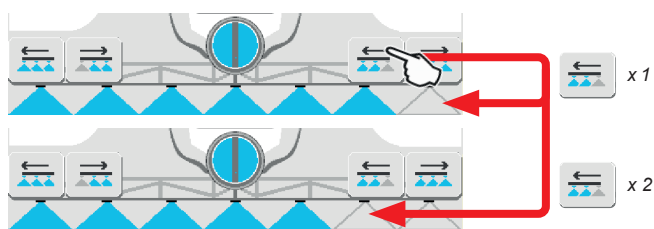

**HYDRAULIC CONTROLS FROM TOUCH-SCREEN PANEL**

Press button to display the Hydraulic controls page

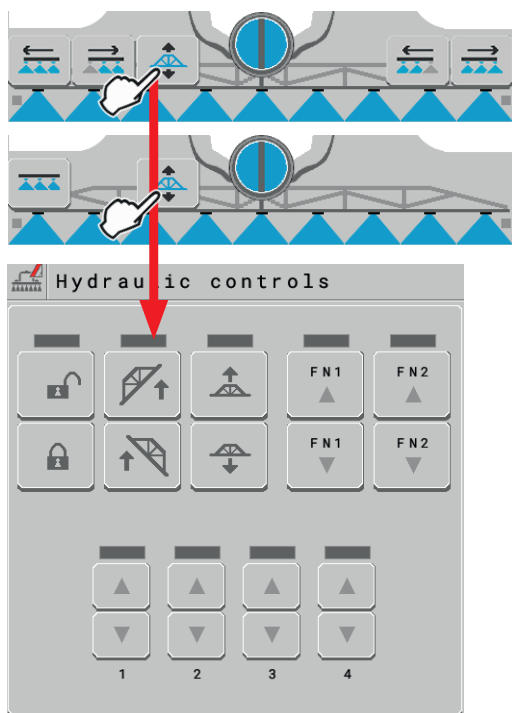

- Boom release
- Boom lock
- Boom counter-clockwise leveling
- Boom clockwise leveling
- Boom height increase
- Boom height decrease
- N1 functions grouping controls (par. 11.9)
- FN2 functions grouping controls (par. 11.9)
- Movement of section of boom: opening
- Movement of section of boom: closing

**16 ARAG JOYSTICK1: ARAG DEFAULT FUNCTIONS**

The functions described below are illustrative. The following contents may NOT be updated and may differ from the product in your possession.

Press to scroll pages.   keys

O = opens the hydraulic valve  
C = closes the hydraulic valve

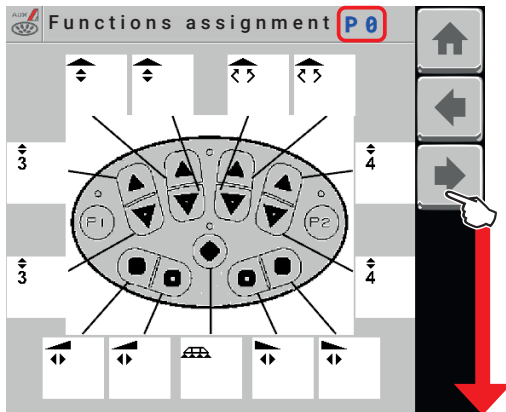

**"Main" page (P0)**

3			4
Var. geom. L (A) Var. geom. L (C)	Height (A) Height (C)	Boom tilt (A) Boom tilt (C)	Var. geom. R (A) Var. geom. R (C)
Seq. 1 LH	Seq. 1 RH	Main valve switch key	Seq. 2 LH

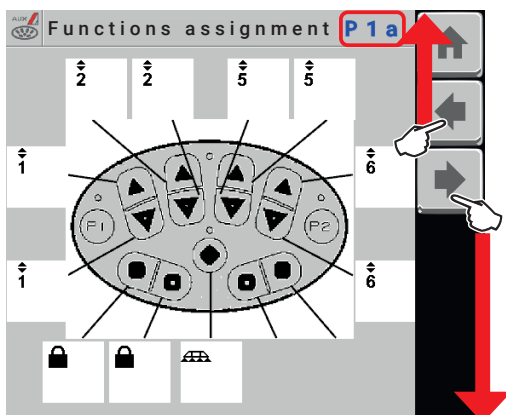

**PAGE 1a**

1	2	5	6
Arm no. 2 L (A) Arm no. 2 L (C)	Arm no. 1 L (A) Arm no. 1 L (C)	Arm no. 1 R (A) Arm no. 1 R (C)	Arm no. 2 R (A) Arm no. 2 R (C)
Boom lock (A)	Boom lock (C)	Main valve switch key	Not mapped

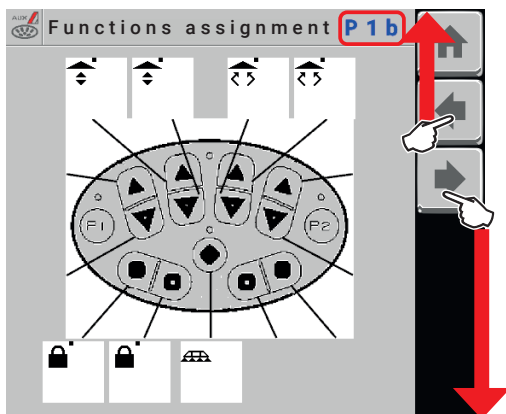

**PAGE 1b**

Not mapped			Not mapped
-- --	Height (A) Height (C)	Boom tilt (A) Boom tilt (C)	-- --
Boom lock (A)	Boom lock (C)	Main valve switch key	Not mapped

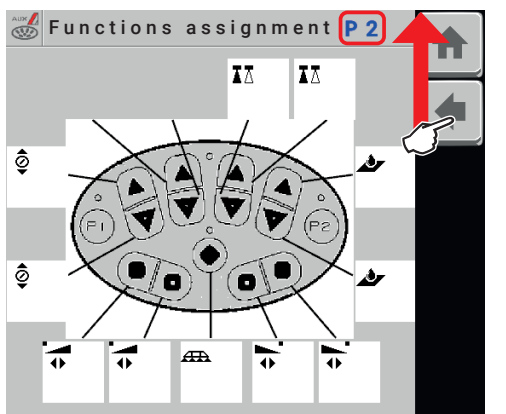

**PAGE 2**

	Not mapped		
Pressure + Pressure -	-- --	Nozzle selection AUTO/MAN switch	Spray rate AUTO/MAN switch
Seq. 1 LH	Seq. 1 RH	Main valve switch key	Seq. 2 LH

17 ARAG JOYSTICK2: ARAG DEFAULT FUNCTIONS

The functions described below are illustrative. The following contents may NOT be updated and may differ from the product in your possession.

Press to scroll pages.   keys

O = opens the hydraulic valve  
C = closes the hydraulic valve

SINGLE PAGE

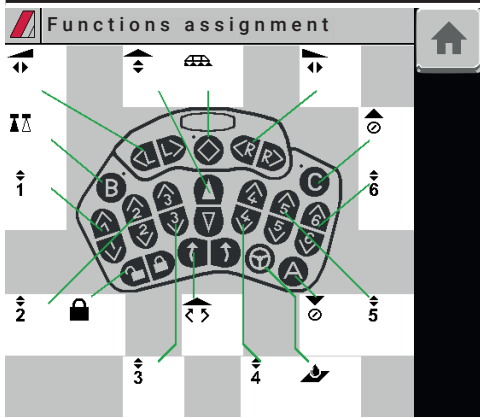

B Nozzle selection AUTO/MAN switch	 Seq. 1 LH   Seq. 1 RH	 Main valve switch	 Seq. 2 LH   Seq. 2 RH
C Pressure +	 Arm no. 2 L (A) Arm no. 2 L (C)	 Arm no. 1 L (A) Arm no. 1 L (C)	 Var. geom. L (A) Var. geom. L (C)
 Height (A) Height (C)	 Var. geom. R (A) Var. geom. R (C)	 Arm no. 1 R (A) Arm no. 1 R (C)	 Arm no. 2 R (A) Arm no. 2 R (C)
 Boom lock (A)   Boom lock (C)	 Boom tilt (A)   Boom tilt (C)	 Spray rate AUTO/MAN switch	A Pressure -

MULTIPLE PAGE

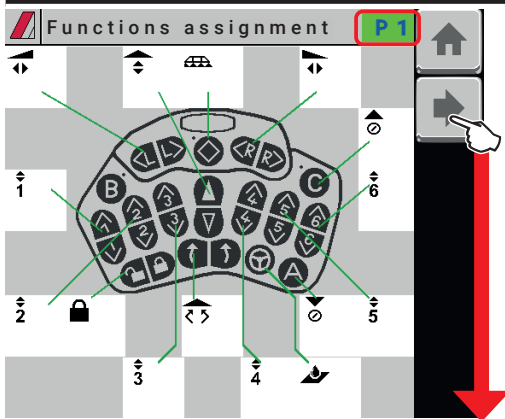

PAGE 1			
 Seq. 1 LH   Seq. 1 RH	 Main valve switch	 Seq. 2 LH   Seq. 2 RH	C Pressure +
 Arm no. 2 L (A) Arm no. 2 L (C)	 Arm no. 1 L (A) Arm no. 1 L (C)	 Var. geom. L (A) Var. geom. L (C)	 Height (A) Height (C)
 Var. geom. R (A) Var. geom. R (C)	 Arm no. 1 R (A) Arm no. 1 R (C)	 Arm no. 2 R (A) Arm no. 2 R (C)	 The page changes every time it is pressed
 Boom lock (A)   Boom lock (C)	 Boom tilt (A)   Boom tilt (C)	 Spray rate AUTO/MAN switch	A Pressure -

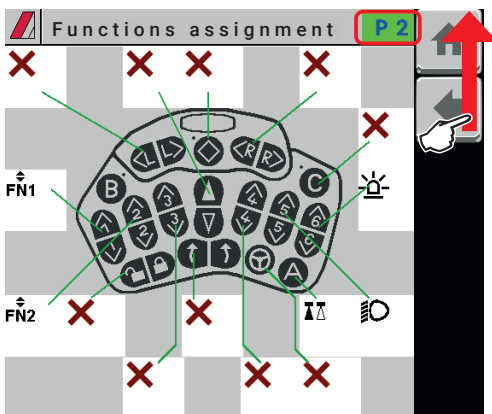

PAGE 2			
 NOT used   NOT used	 NOT used	 NOT used   NOT used	C NOT used
 FN1 functions ON FN1 functions OFF	 FN2 functions ON FN1 functions OFF	 NOT used NOT used	 NOT used NOT used
 NOT used NOT used	 Boom lighting ON Boom lighting OFF	 Flasher ON Flasher OFF	 The page changes every time it is pressed
 NOT used   NOT used	 NOT used   NOT used	 NOT used	A AUTO/MAN switch Nozzle selection

17.1 End nozzles

**"BUFFER ZONE" FUNCTION ENABLED - ONLY FOR SELETRON SYSTEM**

Some spraying modes entail special areas called "Buffer zones", where spraying must be reduced or absent. Besides the normally used nozzles, special nozzles must be installed (e.g.: ASJ AOC), which reduce the jet or the drift effect at boom end sides. To connect the "Buffer" nozzles, proceed as follows:  
 LH "Buffer" nozzle (boom view from back), 1<sup>st</sup> boom nozzle, 2<sup>nd</sup> boom nozzle,----> No. of boom nozzle, RH "Buffer" nozzle (boom view from back).

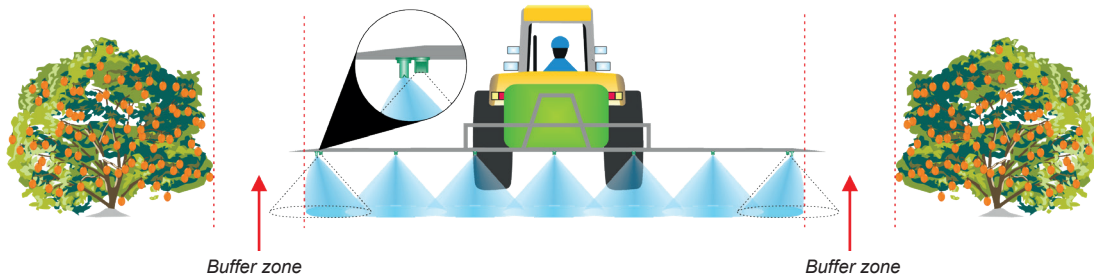
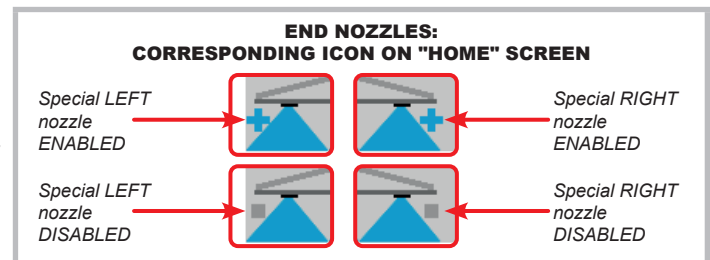

Fig. 149



By enabling the function in implement basic settings (chap. 10) standard nozzles or special nozzles can be alternately selected. Nozzle selection modes are variable (they vary based on the Auxiliary Input connected to the VT). Following are some examples.

**EXAMPLE OF NOZZLE SELECTION THROUGH THE SWITCH BOX**

• LH special nozzle enabling (Boom view from back)



Press switch to the left once to enable the LH "Buffer zone" nozzle and to close the standard one. The LED on the left flashes alternately.

• RH special nozzle enabling (Boom view from back)



Press switch to the right once to enable the RH "Buffer zone" nozzle and to close the standard one. The LED on the right flashes alternately.

• LH special nozzle disabling (Boom view from back)



Press switch to the right once to disable the LH "Buffer zone" nozzle and to enable the standard one. The LED on the left no longer flashes and is steady.

• RH special nozzle disabling (Boom view from back)



Press switch to the left once to disable the RH "Buffer zone" nozzle and to enable the standard one. The LED on the right no longer flashes and is steady.

**EXAMPLE OF NOZZLE SELECTION THROUGH THE JOYSTICK**

The operation is similar to the one just described for the sequential switch box. The functions associated to nozzle enabling are included in the "Main" page. For further details, refer to the instructions provided with the joystick.

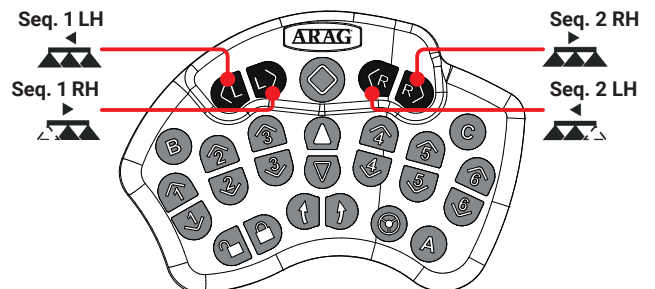
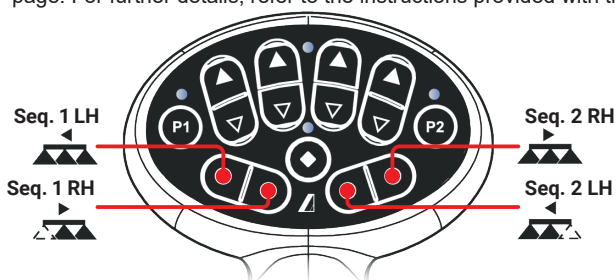

**"FENCE NOZZLE" function enabled**

This function entails the assembly of specific nozzles at boom end; these nozzles allow spraying areas that cannot be reached by the traditional nozzles due to the boom size (i.e. fences). The enabling of such nozzles does not stop the output from the other boom nozzles. The connection and pairing procedure of seletron devices and "Fence" nozzles is the following: at first connect all boom nozzles, then the left "Fence" nozzle and the right "Fence" nozzle. By setting the reference flowrate and pressure for the "Fence" nozzle, it is possible to control the output of all nozzles based on the set spray rate. The width covered by the fence nozzle is not included in the calculation of the applied area.

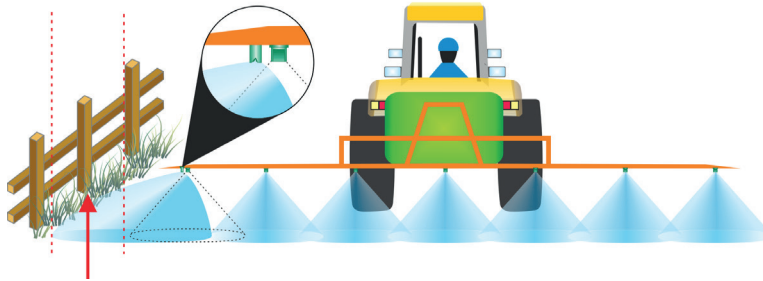
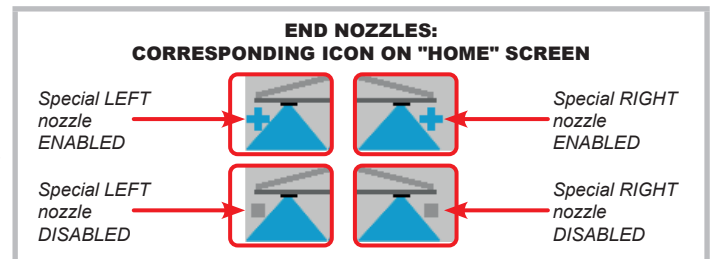

Fig. 150

Fence zone

By activating the function in the basic settings of the implement (chap. 10) it is possible to select normal or special nozzles: the activation of the "Fence" nozzles does not interrupt the delivery of the other boom nozzles. Nozzle selection modes are variable (they vary based on the Auxiliary Input connected to the VT). Following are some examples.



**EXAMPLE OF NOZZLE SELECTION THROUGH THE SWITCH BOX**

• LH special nozzle enabling (Boom view from back)



Press switch to the left once to enable the LH "Fence" nozzle. The LED on the left flashes alternately.

• RH special nozzle enabling (Boom view from back)

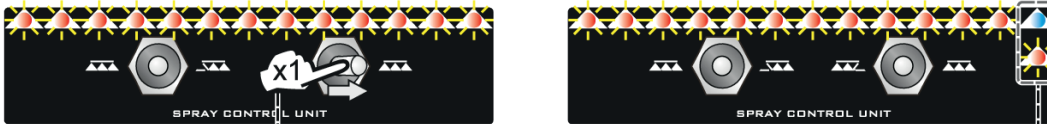

Press switch to the right once to enable the RH "Fence" nozzle. The LED on the right flashes alternately.

• LH special nozzle disabling (Boom view from back)

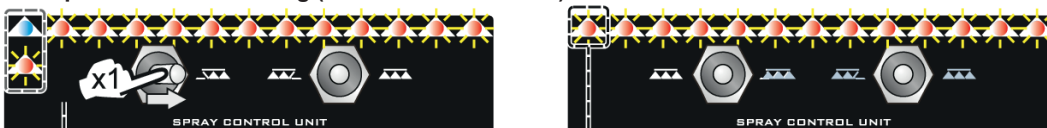

Press switch to the right once to disable the LH "Fence" nozzle. The LED on the left no longer flashes and is steady.

• RH special nozzle disabling (Boom view from back)



Press switch to the left once to disable the RH "Fence" nozzle. The LED on the right no longer flashes and is steady.

**EXAMPLE OF NOZZLE SELECTION THROUGH THE JOYSTICK**

The operation is similar to the one just described for the sequential switch box. The functions associated to nozzle enabling are included in the "Main" page. For further details, refer to the instructions provided with the joystick.

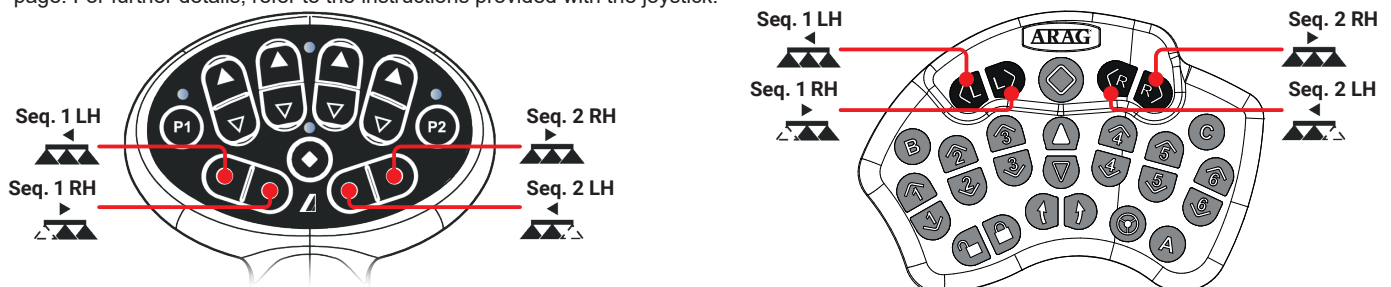

**17.2 Home > Seletron manual control**

It allows you to manage each individual Seletron by turning it off or on manually.

From "Home" screen, press .

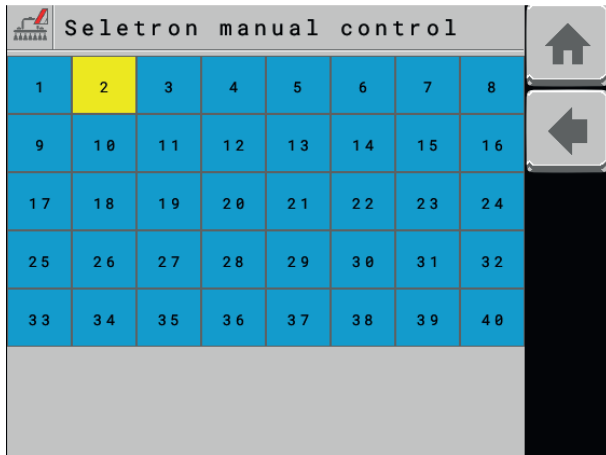

Fig. 151

Press on the square related to the Seletron you wish to activate/deactivate:  
 Blue square = Seletron working  
 Yellow square = Seletron NOT working

Each press of the square changes the Seletron status

**Function available only if the menu:**  
**Data and settings > User preferences > Home screen optional buttons > Section control activation** is active.

**17.3 Home > Pump rate control type**

Allows rate control to be managed through the pump.

From "Home" screen, press .

- Pump off
- Pump on with treatment OFF
- Pump on with treatment ON

**Function available only if the menu:**  
**Data and settings > Implement settings > Basic settings > Rate control type > Pump control.**







**17.4 Home > Section control**

Enables / Disables automatic section control.

From "Home" screen, press .

Each time the button is pressed, the function is activated or deactivated.

**Function available only if the menus are set:**  
**Data and settings > Implement settings > System configurations > Task controller > Section control** activated.  
**Data and settings > User preferences > Home screen optional buttons > Section control activation** activated.

	Goes back to main screen		Goes back to previous menu, or scrolls the pages of a menu (previous page)		Quits without confirming the changes
	Saves the changes to current page		Scrolls the pages of a menu (next page)		Saves the changes



17.5 Home > Syncro control

The user can access the functions of the connected Syncro ISOBUS: execute available commands, view info and alarms.

The user **CANNOT** program the Syncro.

From "Home" screen, press .

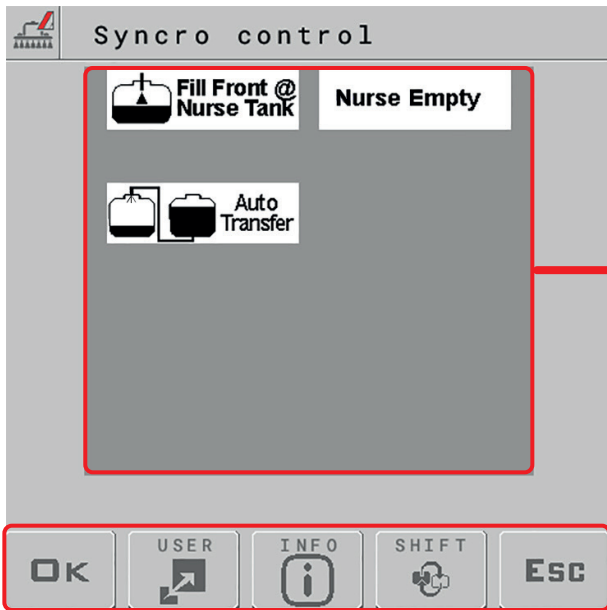

 Please, refer to the relevant instruction manual (download area of the site "[www.aragnet.com](http://www.aragnet.com)").

Fig. 152









This page is not available to the remote connection.

**ALARM DISPLAYED WHEN A COMMAND IS NOT ACCESSIBLE FROM VT: USE ISOBUS SYNCRO.**

To make the adjustment press this area



in the Home page and follow the instructions in par. 15.1.

	Goes back to main screen		Goes back to previous menu, or scrolls the pages of a menu (previous page)		Quits without confirming the changes
	Saves the changes to current page		Scrolls the pages of a menu (next page)		Saves the changes

**18 MAINTENANCE / DIAGNOSTICS / REPAIRS**

**18.1 Cleaning rules**

- Clean only with a soft wet cloth.
- **DO NOT** use aggressive detergents or products.
- **DO NOT** aim water jets directly at control unit.

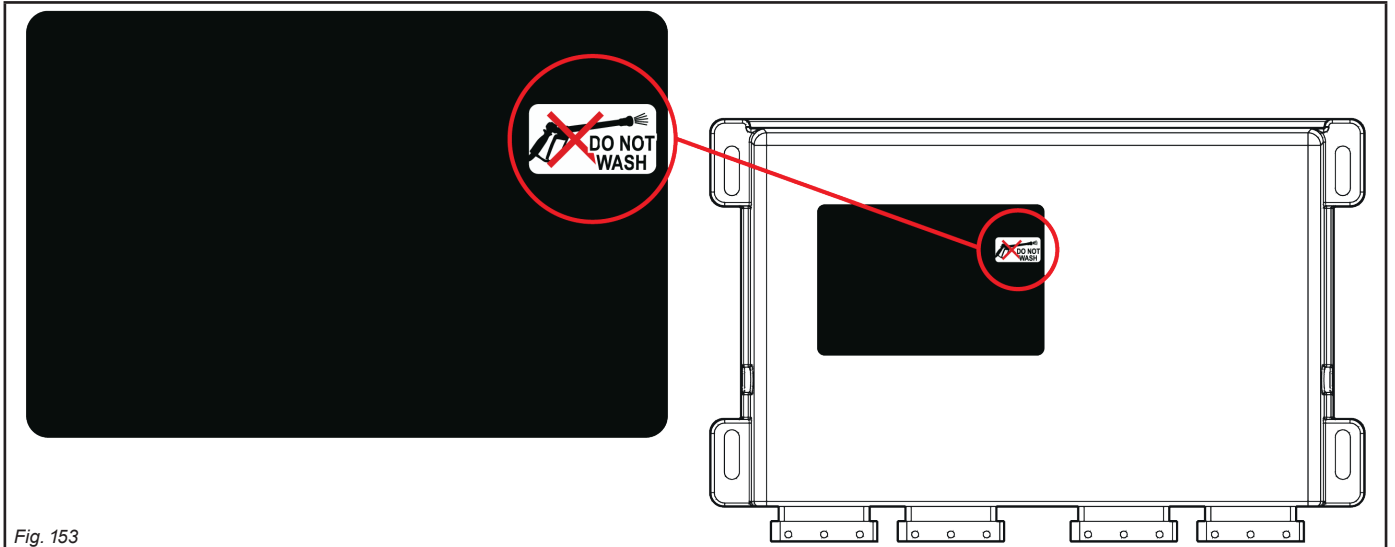
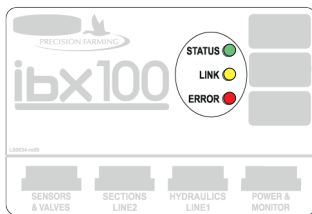

Fig. 153

**18.2 LED status key**



COLOR	
STATUS	● green
LINK	● yellow
ERROR	● red

- **regular blinking** = constant blinking
- **periodical blinking** = series of blinks interrupted by a pause



**Switching on** Upon start-up, the control unit carries out the **LED switching on in a sequence**, as follows:  
**1 green LED - 2 yellow LED - 3 red LED**  
 Whole sequence duration: 2 seconds

- STATUS** ●
- **off**: control unit not powered
  - **steady on**: control unit operational
  - **1 periodical blink**: control unit initialization
  - **2 Periodic blinks**: the control unit has been correctly initialized and is waiting for connection with Virtual Terminal
  - **3 periodical blinks**: OP loading
  - **4 periodical blinks**: ERROR - OP loading on Virtual Terminal failed
  - **5 periodical blinks**: SEVERE ERROR - internal flash drive formatting in progress

- LINK** ●
- **steady ON**: CAN-Bus communication lines operate regularly
  - **1 periodical blink**: error on CAN ISOBUS line
  - **2 periodical blinks**: error on CAN LINE 1 (Seletron)
  - **3 periodical blinks**: error on CAN LINE 2 (Seletron)

- ERROR** ●
- **OFF**: no error
  - **1 periodical blink**: temperature too high
  - **2 periodical blinks**: supply voltage out of range
  - **3 periodical blinks**: BUS 1 (LINE 1) short circuit or absorption too high
  - **4 periodical blinks**: BUS 2 (LINE 2) short circuit or absorption too high
  - **5 periodical blinks**: hydraulic circuit short circuit or absorption too high
  - **6 periodical blinks**: control valve short circuit or absorption too high
  - **7 periodical blinks**: section valve short circuit or absorption too high
  - **8 periodical blinks**: analog sensor connection problem

18.3 Error messages

MESSAGE ON DISPLAY	CAUSE	SOLUTION	WORK MODE
Disable main valve switch	Main switch ON upon switching on	• Disable main control (OFF)	--
Move forward! The machine is stopped	Main control ON with machine stopped	• Start the machine • Disable main control (OFF)	Master ON + Regulation AUTO ON 
Hyd-ECU not detected!	Communication problems between VT hydraulic control unit (Hyd-ECU)	• Check condition of connection cables (and connectors)	--
	The cables are damaged	• Replace the cable	--
Enable pump! No flowrate	Main control ON but flowrate at zero	• Start the pump and move the machine	Master ON + Regulation AUTO ON 
Minimum tank level reached!	Tank level is lower than the set reserve value	• Fill the tank	Master ON
	Minimum value was not set correctly	• Check set reserve value	
Maximum tank level reached!	Tank level has reached the maximum set value	• Stop tank filling phase	--
Low pressure! Regulation locked.	Pressure does not reach set value	• Increase driving speed	Master ON + Regulation AUTO ON 
	Limit was not set correctly	• Check set limit	
Slow down! High pressure	The pressure exceeds the maximum level allowed for the nozzle being used	• Decrease driving speed • Adjust the operating pressure so as to respect the previously set limits for nozzles in use • Check maximum pressure setting for nozzles in use	Master ON
Accelerate! Low pressure	The pressure does not reach the minimum value for the nozzle in use	• Increase driving speed • Adjust the operating pressure so as to respect the previously set limits for nozzles in use • Check minimum pressure setting for nozzle in use	Master ON
Flowmeter out of max value Flowmeter out of min value Flowrate out of range (Max) Flowrate out of range (Min)	Flowrate out of the limits allowed by flowmeter	• Modify working conditions to suit flowmeter limits (speed, pressure, etc.) • Make sure that flowmeter parameters are set correctly	Master ON
Slow down! Too low flow rate!	Flowrate does not reach the value requested for output	• Decrease driving speed • Make sure that flowmeter parameters are set correctly	Master ON + Regulation AUTO ON 
Accelerate! Too high flowrate!	The flowrate exceeds the value required for output	• Increase driving speed • Check that the setup of the menu <b>Implement settings</b> (boom width, flowmeter, etc.) has been set correctly	Master ON + Regulation AUTO ON 
Reduce rotation speed!	RPM exceeds the maximum set value	• Decrease the rotation speed of the moving part • Check the constant set for the rev counter	--
Increase rotation speed!	RPM does not reach the minimum value	• Increase the rotation speed of the moving part • Check the constant set for the rev counter	Master ON
Nozzles wear check	Difference between measured and calculated flowrate (according to selected nozzle data) higher than set value	• Check that the set nozzle coincides with the one installed on the boom • Replace nozzles	Master ON + Regulation AUTO ON 
Seletron system failure!	One or more spraying points do not respond	• Identify the unrecognized spraying point • Check that the corresponding spraying point is connected correctly • Check condition of harness on the corresponding spraying point	--
Seletron system error!	Low supply voltage on one or more spraying points	Check battery voltage level	--
		• Identify the unrecognized spraying point • Check condition of harness on the corresponding spraying point	--

18.4 Troubleshooting

PROBLEM	CAUSE	SOLUTION
Section valve controls take no effect	Valves not connected	• Connect the IN-CAB cable and the connection cable to the valves.
One valve does not open	No power supply to valve	• Check valve electric connection and operation.
The display no longer shows the speed	Wrong setup	• Check the setup of the wheel constant.
	No signal coming from the speed sensor	• Check connections to speed sensor.
The displayed speed is not precise	Wrong setup	• Check the setup of the wheel constant.
Output volume readout inaccurate	Wrong setup	• Check the setup of the boom width. • Check the setup of the flowmeter constant. • Check the setup of the wheel constant. • Check the setup of the section valve type. • Check connections to speed sensor.
Covered area count displayed does not match actual area covered	Wrong setup	• Check the setup of the boom width. • Check the setup of the wheel constant. • Check connections to speed sensor.
	Counter not reset	• Reset the counter.
Distance traveled count displayed does not match actual distance covered	Wrong setup	• Check the setup of the wheel constant. • Check connections to speed sensor.
	Counter not reset	• Reset the counter.
Sprayed fluid count displayed does not match liters/gpm actually sprayed	Wrong setup	• Check the setup of the flowmeter constant. • Check the setup of the section valve type.
	Counter not reset	• Reset the counter.
	Use of three-way section valves without setting metered by-passes	• Perform setting.
Time count displayed does not match actual work time	Counter not reset	• Reset the counter.
Unable to reach output volume value set for the automatic operation	Wrong setup	• Check spray rate setup. • Check the setup of the boom width.
	System not adequately sized to provide required flowrate	• Check maximum pressure valve adjustment. • Make sure control valve is adequate for specific system.
	Control valve malfunction	• Check valve operation.
Instantaneous pressure readout inaccurate	Wrong setup	• Check full scale setup for pressure sensor.
	Pressure sensor not calibrated	• Perform setting.
	Pressure sensor wrong installation	• Check connections to pressure sensor.
Instantaneous pressure is not displayed	Wrong setup	• Check pressure sensor setting.
	IBX100 does not receive signals from pressure sensor	• Check connections to pressure sensor.
	Pressure sensor wrong installation	• Check connections to pressure sensor.
Rpm readout inaccurate	Wrong setup	• Check rpm sensor constant setting.
Rpm value not displayed	IBX100 does not receive signals from RPM sensor	• Check connections to RPM sensor.
	Rpm sensor wrong installation	• Check connections to RPM sensor.

19.4 Pin-out of IBX100

**VALVE sprayer technology**

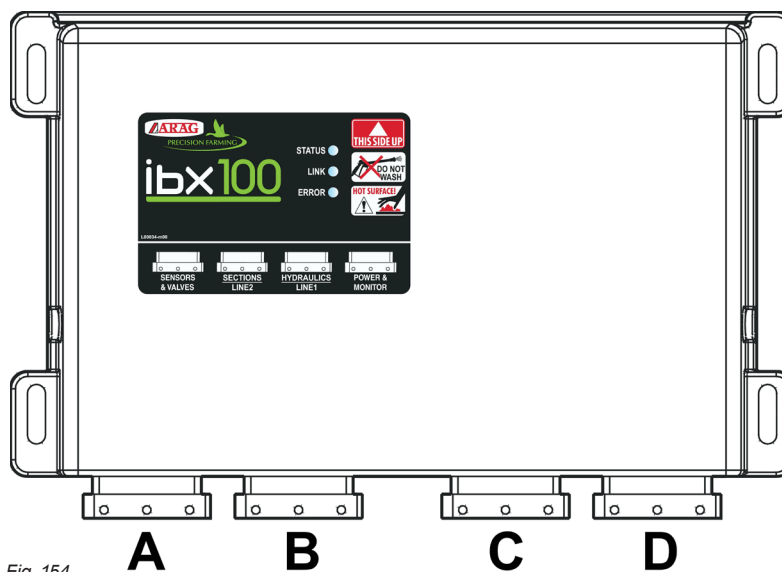

Fig. 154

<b>A</b>		<b>B</b>		<b>C</b>		<b>D</b>	
<b>SENSOR CABLE</b>		<b>H2O VALVES (7/14 sections)</b>		<b>HYD VALVES</b>		<b>ISOBUS CABLE Tractor / Self-propelled</b>	
<b>PIN</b>	<b>IBX100 signal</b>	<b>PIN</b>	<b>IBX100 signal</b>	<b>PIN</b>	<b>IBX100 signal</b>	<b>PIN</b>	<b>IBX100 signal</b>
A1	12V sensor power supply	A1	Power supply GND	A1	Valve AC	A1	PWR
A2	Pressure sensor (M)	A2	Valve 1	A2	Valve AA	A2	-
A3	Level sensor 1 (L main tank)	A3	Valve 2	A3	Valve BC	A3	-
A4	Level sensor 2 (secondary tank)	A4	Valve 3	A4	Valve BA	A4	-
A5	-	A5	Valve 4	A5	Valve CC	A5	-
A6	-	A6	Valve 5	A6	Valve CA	A6	-
A7	-	A7	Valve 6	A7	Valve DD	A7	PWR
A8	Sensor power supply GND	A8	Power supply 12V	A8	-	A8	PWR
B1	Proportional valve	B1	Power supply GND	B1	Valve power supply Hyd GND	B1	PWR GND
B2	Spraying activation / deactivation	B2	Valve 7	B2	Valve 1A	B2	-
B3	-	B3	-	B3	Valve 1C	B3	CAN L
B4	-	B4	-	B4	Valve 2A	B4	CAN H
B5	Boom lock sensor	B5	Valve 8	B5	Valve 2C	B5	-
B6	-	B6	Valve 9	B6	Valve 3A	B6	-
B7	-	B7	Activation Fence LH	B7	Valve 3C	B7	ECU-POWER
B8	Valve power supply G 12V	B8	Power supply 12V	B8	-	B8	PWR
C1	Proportional valve	C1	Power supply Fence GND	C1	-	C1	PWR GND
C2	Speed sensor (S)	C2	Valve 10	C2	Valve 4A	C2	PWR GND
C3	Flowmeter (F)	C3	Valve 11	C3	Valve 4C	C3	-
C4	Filling flowmeter (T)	C4	Valve 12	C4	Valve 5A	C4	-
C5	RPM sensor (X)	C5	Valve 13	C5	Valve 5C	C5	TBC-POWER
C6	Flasher (Light)	C6	Valve 14	C6	Valve 6A	C6	TBC GND
C7	Boom lighting (Light)	C7	Activation Fence RH	C7	Valve 6C	C7	ECU-POWER GND
C8	Valve power supply G GND	C8	Power supply Fence 12V	C8	Valve power supply Hyd GND	C8	PWR GND

**SELETRON sprayer technology**

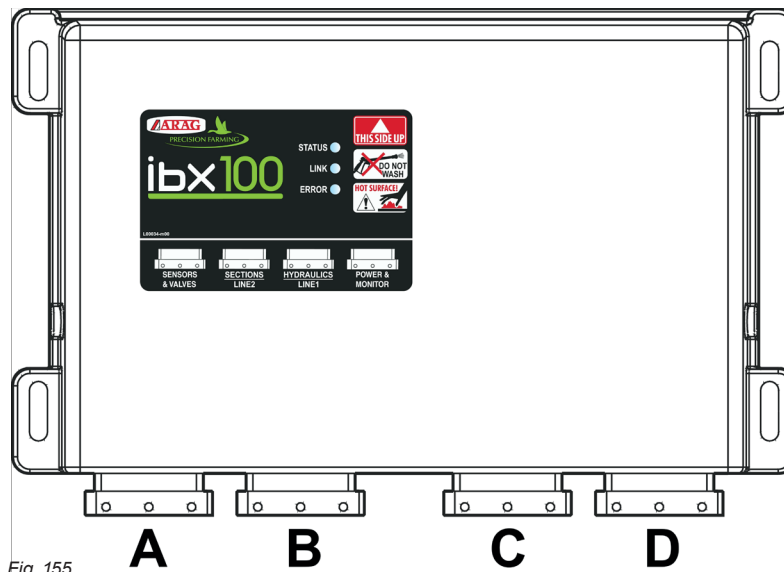

Fig. 155

<b>A</b>		<b>B</b>		<b>C</b>		<b>D</b>	
<b>SENSOR CABLE</b>		<b>SELETRON Line 2</b>		<b>SELETRON Line 1</b>		<b>ISOBUS CABLE Tractor / Self-propelled</b>	
<b>PIN</b>	<b>IBX100 signal</b>	<b>PIN</b>	<b>IBX100 signal</b>	<b>PIN</b>	<b>IBX100 signal</b>	<b>PIN</b>	<b>IBX100 signal</b>
A1	Sensor power supply 12V	A1	GND	A1	GND	A1	PWR
A2	Pressure sensor (M)	A2	-	A2	-	A2	-
A3	Level sensor 1 (L main tank)	A3	-	A3	-	A3	-
A4	Level sensor 2 (secondary tank)	A4	-	A4	-	A4	-
A5	-	A5	-	A5	-	A5	-
A6	-	A6	-	A6	-	A6	-
A7	-	A7	-	A7	-	A7	PWR
A8	Sensor power supply GND	A8	VBAS	A8	VBAS	A8	PWR
B1	Proportional valve	B1	GND	B1	GND	B1	PWR GND
B2	Spraying activation / deactivation	B2	-	B2	-	B2	-
B3	-	B3	CAN L	B3	CAN L	B3	CAN L
B4	-	B4	CAN H	B4	CAN H	B4	CAN H
B5	Boom lock sensor	B5	-	B5	-	B5	-
B6	-	B6	-	B6	-	B6	-
B7	-	B7	-	B7	-	B7	ECU-POWER
B8	Valve power supply G 12V	B8	VBAS	B8	VBAS	B8	PWR
C1	Proportional valve	C1	GND	C1	GND	C1	PWR GND
C2	Speed sensor (S)	C2	-	C2	-	C2	PWR GND
C3	Flowmeter (F)	C3	-	C3	-	C3	-
C4	Filling flowmeter (T)	C4	-	C4	-	C4	-
C5	RPM sensor (X)	C5	-	C5	-	C5	TBC-POWER
C6	Flasher (Light)	C6	-	C6	-	C6	TBC GND
C7	Boom lighting (Light)	C7	-	C7	-	C7	ECU-POWER GND
C8	Valve power supply G GND	C8	VBAS	C8	VBAS	C8	PWR GND

**19 TECHNICAL DATA**

**19.1 Electrical features**

Nominal supply voltage.....	9 ÷ 16 Vdc
Protection against polarity inversion.....	Yes
Protection against short-circuit.....	Yes
Digital inputs.....	For Open collector sensors: max. frequency 2000 Hz
Analogue inputs.....	4-20 mA
Digital outputs (valves).....	Active high (max 200 mA)
Hydraulic valves power outputs.....	Active high (max 2,5a)
Seletron lines power outputs.....	Active high (max 15 A)

**19.2 Environmental features**

Operating temperature.....	-40 °C ÷ +60 °C / -40 °F ÷ +140 °F
Storage temperature.....	-40 °C ÷ +85 °C / -40 °F ÷ +185 °F

**19.3 Physical features**

Weight (without cables).....	1213 g
------------------------------	--------

**20 END-OF-LIFE DISPOSAL**

Dispose of the system in compliance with the established legislation in the country of use.

**21 GUARANTEE TERMS**

1. ARAG s.r.l. guarantees this apparatus for a period of 360 days (1 year) from the date of sale to the client user (date of the goods delivery note).  
The components of the apparatus, that in the unappealable opinion of ARAG are faulty due to an original defect in the material or production process, will be repaired or replaced free of charge at the nearest Assistance Center operating at the moment the request for intervention is made. The following costs are excluded:
  - disassembly and reassembly of the apparatus from the original system;
  - transport of the apparatus to the Assistance Center.
2. The following are not covered by the guarantee:
  - damage caused by transport (scratches, dents and similar);
  - damage due to incorrect installation or to faults originating from insufficient or inadequate characteristics of the electrical system, or to alterations resulting from environmental, climatic or other conditions;
  - damage due to the use of unsuitable chemical products, for spraying, watering, crop sprayer or any other crop treatment, that may damage the apparatus;
  - malfunctioning caused by negligence, mishandling, lack of know how, repairs or modifications carried out by unauthorized personnel;
  - incorrect installation and regulation;
  - damage or malfunction caused by the lack of ordinary maintenance, such as cleaning of filters, nozzles, etc.;
  - anything that can be considered to be normal wear and tear;
3. Repairing the apparatus will be carried out within time limits compatible with the organizational needs of the Assistance Center.  
No guarantee conditions will be recognized for those units or components that have not been previously washed and cleaned to remove residue of the products used;
4. Repairs carried out under guarantee are guaranteed for one year (360 days) from the replacement or repair date.
5. ARAG will not recognize any further expressed or intended guarantees, apart from those listed here.  
No representative or retailer is authorized to take on any other responsibility relative to ARAG products.  
The period of the guarantees recognized by law, including the commercial guarantees and allowances for special purposes are limited, in length of time, to the validities given here.  
In no case will ARAG recognize loss of profits, either direct, indirect, special or subsequent to any damage.
6. The parts replaced under guarantee remain the property of ARAG.
7. All safety information present in the sales documents regarding limits in use, performance and product characteristics must be transferred to the end user as a responsibility of the purchaser.
8. Any controversy must be presented to the Reggio Emilia Law Court.

**22 EU DECLARATION OF CONFORMITY**

The declaration of conformity is available at the website [www.aragnet.com](http://www.aragnet.com), in the relevant section.

---

*Only use genuine ARAG accessories or spare parts to make sure manufacturer guaranteed safety conditions are maintained in time. Always refer to the Internet address [www.aragnet.com](http://www.aragnet.com)*

D20354\_GB-m06 05/2023



42048 RUBIERA (Reggio Emilia) - ITALY  
Via Palladio, 5/A

Tel. +39 0522 622011  
Fax +39 0522 628944

<http://www.aragnet.com>  
[info@aragnet.com](mailto:info@aragnet.com)